

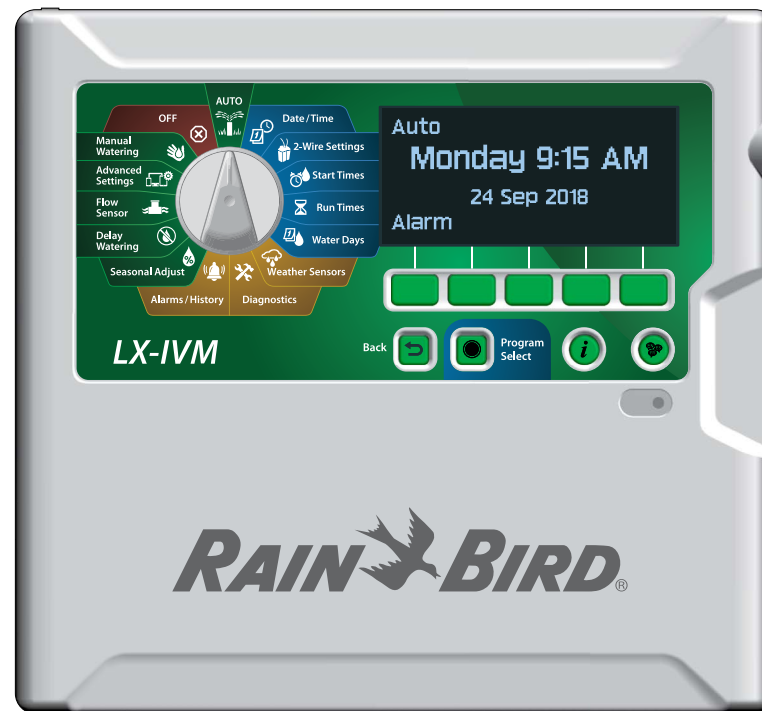

ESP-LXIVM Series Controllers

Installation, Programming & Operation Guide



Hazardous Warnings

WARNING

Indicates a hazardous situation that, if not avoided, could result in death or serious injury.

CAUTION

Indicates a hazardous situation that, if not avoided, could result in minor or moderate injury.



NOTICE

Indicates information considered important, but not hazard-related (e.g., messages relating to property damage).

SAFETY INSTRUCTIONS

Specific safety-related instructions or procedures are described.

Symbols & User Operation

-  **NUMBERS** define a series of steps for the user to follow in order to operate the controller.
-  **NOTE:** Notifies the user of important operating instructions related to controller functionality, installation or maintenance.
-  **REPEAT:** Indicates that a repetition of previous steps or actions may be required for further operation, or to complete a process.

Technical Support

Questions?

Call Rain Bird toll free Technical Support at **1-866-544-1406**
(USA and Canada only)

Regulatory Information

Federal Communications Commission

Supplier's Declaration of Conformity

47 CFR § 2.1077 Compliance Information

Unique Identifier:

IESPLXIVM, IESPLXIVMP, ILXIVMEU, ILXIVMPEU, LXIVMPFP, LXIVMFP, LXIVMSOL, LXIVMOUT, LXIVMSEN, LXIVMSD and LXIVM2WMOD

Responsible Party – U.S. Contact Information

Rain Bird Corporation
9491 Ridgehaven Court
San Diego, CA 92123 USA

Ph. (858) 268 2650

FCC Compliance Statement

This device complies with part 15 of the FCC Rules. Operation is subject to the following two conditions: (1) This device may not cause harmful interference, and (2) this device must accept any interference received, including interference that may cause undesired operation.

Note: This equipment has been tested and found to comply with the limits for a Class B digital device, pursuant to part 15 of the FCC Rules. These limits are designed to provide reasonable protection against harmful interference in a residential installation. This equipment generates, uses and can radiate radio frequency energy and, if not installed and used in accordance with the instructions, may cause harmful interference to radio communications. However, there is no guarantee that interference will not occur in a particular installation. If this equipment does cause harmful interference to radio or television reception, which can be determined by turning the equipment off and on, the user is encouraged to try to correct the interference by one or more of the following measures:

- Reorient or relocate the receiving antenna.
- Increase the separation between the equipment and receiver.
- Connect the equipment into an outlet on a circuit different from that to which the receiver is connected.
- Consult the dealer or an experienced radio/TV technician for help.

IC Canada Statement

The Class B apparatus meets all requirements of the Canadian ISED (formerly IC) regulations
- CAN ICES-3 (B)/NMB-3 (B).

Cet appareil de classe B respecte toutes les exigences de la réglementation canadienne ISED (anciennement IC)- CAN ICES-3 (B)/NMB-3 (B).

Waste Electrical and Electronic Equipment (WEEE)



As a hardware manufacturer, Rain Bird has met its national obligations to the EU WEEE Directive by registering in those countries to which Rain Bird is an importer. Rain Bird has also elected to join WEEE Compliance Schemes in some countries to help manage customer returns at end of life.

Certifications

- cULus, CE, RCM, EAC



DECLARATION OF CONFORMITY

Rain Bird Corporation hereby declares that the following irrigation controllers and accessories are CE compliant.

IESPLXIVM, IESPLXIVMP, ILXIVMEU, ILXIVMPEU, LXIVMSOL, LXIVMOUT, LXIVMSEN, LXIVMSD, LXIVMPFP*, LXIVMFP*, and LXIVM2WMOD*
(*Spare part sold separately - obtained compliance with the controller IESPLXIVM)

This declaration of conformity is issued under the sole responsibility of the manufacturer. The object of the declaration described above is in conformity with the relevant Union harmonization legislation, and the references to the relevant harmonized standards used or to other technical specifications in relation to which conformity is declared are listed below:

Electromagnetic Compatibility (EMC) Directive 2014/30/EU

- EN 55014-1:2006 + A2:2011
EN 55014-2:1997 + A1:2001 + A2:2008

Low Voltage (LVD) Directive 2014/35/EU

- EN 60335-1:2012 + AC:2014 + A11:2014 + A13:2017 including
IEC 60335-1:2010, and EN 62233:2008 + AC:2008
IEC 60335-1 Edition 5.2: 2010 +A1: 2013 +A2: 2016

Restriction of the use of certain Hazardous Substances (RoHS) Directive 2011/65/EU

- EN 50581:2012

Place: San Diego, CA
Signature: [Handwritten Signature]
Full Name: Roger S. Neitzel
Position: Plant and Program Manager
Date: January 8, 2020

Rain Bird Corporation
970 W. Sierra Madre Ave.
Azusa, California 91702, USA
Phone: (626) 812-3400
Fax: (626) 812-3411

Rain Bird International, Inc.
1000 West Sierra Madre Ave.
Azusa, CA 91702, USA
Phone: (626) 963-9311
Fax: (626) 852-7343

Rain Bird Europe
240 Rue René Descartes – Le Clamar Bât. A
13290 Aix En Provence, France
Phone: (33) 4 42 24 44 61
Fax: (33) 4 42 24 24 72

© 2020 Rain Bird Corporation
® Registered Trademark of Rain Bird Corporation

P/N: 690865-01 REV. 08JA20

Safety Information

⚠ WARNING

Special precautions must be taken when valve wires (also known as station or solenoid wires) are located adjacent to, or share a conduit with other wires, such as those used for landscape lighting, other “low voltage” systems or other “high voltage” power.

Separate and insulate all conductors carefully, taking care not to damage wire insulation during installation. An electrical “short” (contact) between the valve wires and another power source can damage the controller and create a fire hazard.

All electrical connections and wiring runs must comply with local building codes. Some local codes require that only a licensed or certified electrician can install power. Only professional personnel should install the controller. Check your local building codes for guidance.

⚠ CAUTION

This appliance is not intended for use by persons (including children) with reduced physical, sensory or mental capacity, or lack of experience and knowledge unless they have been given supervision or instruction concerning use of the appliance by a person responsible for their safety. Children should be supervised to ensure that they do not play with the appliance. Cleaning and user maintenance shall not be made by children without supervision.

If the supply cord of ILXIVMAU or ILXIVMAUP is damaged, it must be replaced by the manufacturer, its service agent or similarly qualified persons in order to avoid a hazard.

Replace with the following: Flexible supply cord H05VVF, minimum wire size of 0.75 mm² (18 AWG). For direct connection wiring: Minimum wiring size is 0.75 mm² (18 AWG).

For controllers not provided with a supply cord, the fixed installation must include a disconnecting device for all three poles suitable for overvoltage category III protection.

NOTICE

Use only Rain Bird approved accessory devices. Changes or modifications not expressly approved by Rain Bird could void the user’s authority to operate the equipment. Unapproved devices may damage the controller and void the warranty. For a list of compatible devices go to: www.rainbird.com

Date and time are retained by a lithium battery which must be disposed of in accordance with local regulations.

Model, serial number, supply rate and fabrication date are located on the back of swing panel.

Waste Electrical and Electronic Equipment (WEEE)



As a hardware manufacturer, Rain Bird has met its national obligations to the EU WEEE Directive by registering in those countries to which Rain Bird is an importer. Rain Bird has also elected to join WEEE Compliance Schemes in some countries to help manage customer returns at end of life.

Certifications

• cULus, CE, RCM, EAC

Contents

Technical Support	2
Introduction & Overview.....	10
ESP-LXIVM Controller Overview	10
Controller Features	10
Controls, Switches and Indicators.....	11
2-Wire path Overview	12
2-Wire path Design.....	12
Star Pattern	12
Loop Pattern	13
2-Wire Devices	14
Types of 2-Wire Devices	14
IVM-SOL Integrated Valve Modules.....	14
IVM-OUT (Output Device).....	14
IVM-SEN (Sensor Device).....	14
IVM-SD (Surge Device)	14
2-Wire Device Addresses	14
Local Weather Sensor	14
Valves (Stations)	16
Advanced Station Settings and Features	16
Programming Overview	17
Programs	17
Watering Start Times	17
Station Run Times	17
Watering Days	17
2-Wire Device Address Labels.....	17
Fill Out the Programming Guide.....	18
Storing the Programming Guide.....	18

Remote Programming	18
Information Button	19
Language Select Button	19
Programming Checklist	20
Set Up Hardware	20
Set Up Programs.....	20
Set Up Programs (Optional)	20
Review Setup	20
Optional Setup	20
AUTO > Alarm.....	21
Automatic Operation	21
Alarms	21
Alarm Detected	21
Alarm Conditions	22
List of Alarm Conditions	22
Date & Time Settings.....	23
2-Wire Setup	24
Master Valves.....	24
Normally Closed Master Valve	25
Normally Open Master Valve	25
NOMV Cycling	25
Weather Sensors	26
Sensor Types	26
Set Up 2-Wire Device Weather Sensors.....	27
Custom Pause Sensors	28
Custom Prevent Sensors	28
Local Weather Sensor	28

Station Setup	28
Set Priority	29
FloZones	30
Weather Sensors	30
Flow Sensors	31
Set Up Rain Bird Flow Sensor	31
Set Up Custom Flow Sensor	32
Advanced Station Settings	33
Cycle+Soak™	33
Copy Station To Station	35
Inter-Station Delay	36
SimulStations	36
Set SimulStations for Program	37
Station Sequencing	38
Station Sequencing by Station Number (Default)	38
Station Sequencing by Station Priority	38
2-Wire Mapping	39
Basic Programming	41
Program Select Button	41
Select Program	41
Back Button	41
Set Watering Start Times	42
Set Station Run Times	43
Copy Run Times	44
Select Water Days	45
Custom, By Day of Week	45
Cyclic Days	46
Custom, Even days, Odd days, Odd no 31st	47

Weather Sensors	48
Connect Local Weather Sensors	48
Supported Rain Bird® Weather Sensors:	48
Diagnostics	49
Test All Stations	49
Diagnostics	50
List Not Responding	50
List Responding	51
Ping Valve/Sensor	52
Test Shorted Paths	53
Controller Output	54
Confirm Programming	55
Program Summary	55
Review Programs	56
Program Run Times	58
Station Run Times	59
Review Master Valves	60
Review Weather Sensors	61
Alarms/History	62
Flow History	62
Flow Alarms	63
Station Flow Alarms	63
FloZone Flow Alarms	64
Clear Flow Alarms	65

Electrical History	66
Stations, Master Valves and Sensors	66
30 Days Electrical History	66
12 Months Electrical History	66
Controller Output	67
30 Days Electrical History	67
12 Months Electrical History	67
Seasonal Adjust	68
Individual Program	68
By Month	69
% Adjust.....	69
Select Programs	70
Delay Watering	71
Rain Delay	71
Calendar Day Off	72
Program Water Window	73
Water Window Set Up	73
Flow Sensor	74
Introduction to Flow	74
FloZones Overview	74
Flow Management Features	74
Flo-Manager®	74
FloWatch™	74
Set Flow Rates	75
Learn Flow Automatically	75
All Stations.....	75
Selected Stations	76

Set Station Rates	78
Set FloZone Rates.....	79
View Flow Rates	80
View Station Rates	80
View FloZone Rates	81
Clear Flow Rates	82
Set Flo-Manager®	83
Flo-Manager® Set Up.....	83
Enable or Disable Flo-Manager®	83
Set FloWatch™	84
FloWatch™ Set Up	84
FloWatch™ On/Off	85
Set Flow Limits.....	86
SEEF (High Flow) and SELF (Low Flow) Settings and Actions	86
Set Up and Configure High Flow and Low Flow.....	86
Set Flow Actions	87
Current Flow Reading	88
Set Flow Units	89
Advanced Settings	90
Store/Recall Programs	90
Store Programs	90
Recall Programs.....	91
Delayed Recall Programs	92
Clear Program Information	93
Clear Individual Program	93
Clear All Programs	94
Factory Defaults	95
About this LX-IVM	96

Manual Watering	97
Start Station	97
Start Program	98
Master Valve Water Window	99
Set Up MV Water Window	99
Manual MV Open	100
Test All Stations	101
OFF	102
Adjust Display Contrast	102
Close Master Valves	102
Turn Off 2-Wire path	103
Power Down or Restore Power to the 2-Wire path	104
Installation	105
Install the Controller	105
Installation Checklist	105
Check Box Contents	105
Select Location for Controller	106
Gather Installation Tools	106
Access Controller Cabinet	107
Open or Remove Controller Front Panel	107
Mount Controller	108
Install IVM 2-Wire Interface Module	109
Connect Field Wiring	110
Connecting the 2-Wire Cable	110

Surge Protection and Grounding	111
ESP-LXIVM Controller	111
IVM 2-Wire Interface Module	111
2-Wire Path	112
Connect Power to the Controller	112
Connect Ground Wire	112
Connect Power Source	113
Complete Installation	115
Programming Under Battery Power	115
IQ™ Central Control System	116
IQ™ Network Communication Cartridge	116
NCC Cartridge Installation (Optional)	116
Configure NCC Cartridge	117
Setup Wizard	117
NCC Configurator	119
IQNCC-RS Status	120
IQNet Alarms	121

Introduction & Overview

Welcome to Rain Bird®

Thank you for purchasing your new state-of-the-art Rain Bird ESP-LXIVM controller.

For eight decades Rain Bird has led the irrigation industry in meeting water management needs by providing the highest quality products and services available.

ESP-LXIVM Controller Overview

Your new Rain Bird controller is designed to provide years of highly manageable irrigation control.

- The LX-IVM controller is designed for commercial use.
- The LX-IVM base model accommodates 60 stations.
- The LX-IVM Pro model has a capacity of up to 240 Stations.

Controller Features

The ESP-LXIVM controller has a variety of advanced features to help you manage water efficiently, including:

- Flow and priority management.
- 2-Wire and controller-based diagnostics.
- Large variety of user-configurable irrigation program options to meet the most demanding irrigation needs.
- Powerful upgrade features include IQ Central Control Communication cartridges.
- Supports local and 2-Wire weather sensor inputs.
- Outdoor-rated plastic cabinet which can be upgraded to an optional metal cabinet and pedestal or stainless steel cabinet and pedestal.
- UL and CE certified

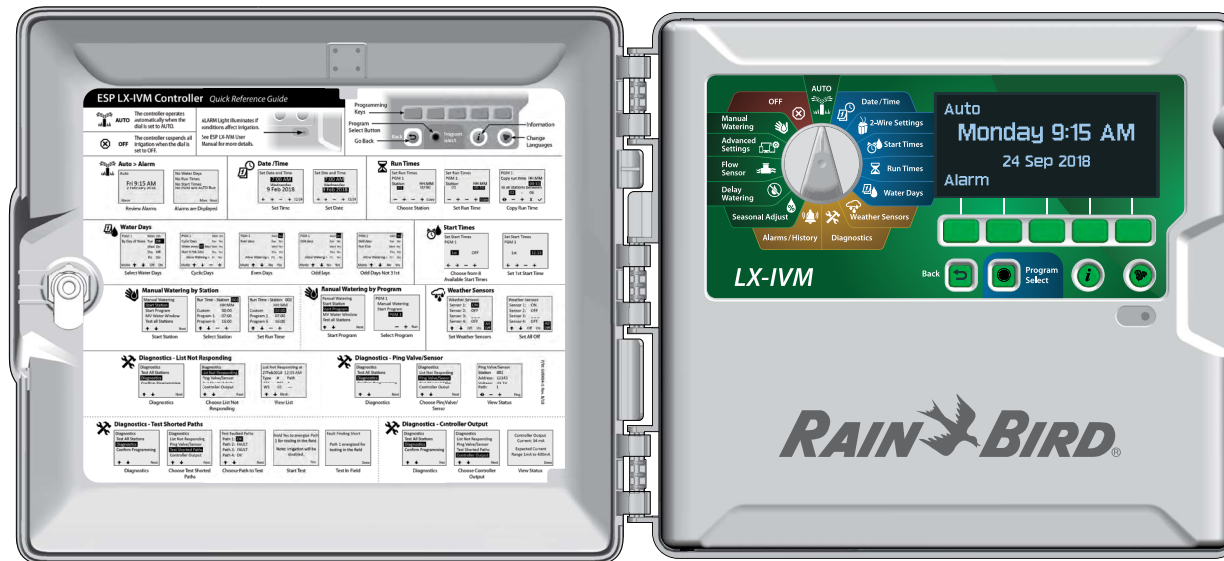

Controls, Switches and Indicators

Key operational features of the ESP-LXIVM Controller:

1 Programming Dial

Used to select irrigation features, programming and to turn the controller on and off.

2 Display

Shows time of day during normal operation; shows commands during programming; shows active station and remaining run time during watering

3 Programming Keys

Press keys to set and change program information.

4 Back Button

During programming, press the Back button to go back to the previous screen.

5 Program Select Button

Select the desired watering Program to set independent irrigation schedules.

6 Information Button

Press to see information about each feature on the dial and screen.

7 Language Button

Press to change the interface language. Choose from English, Spanish, French, German, Portuguese or Italian.

8 Alarm Light

Illuminates to indicate various types of alarm conditions.

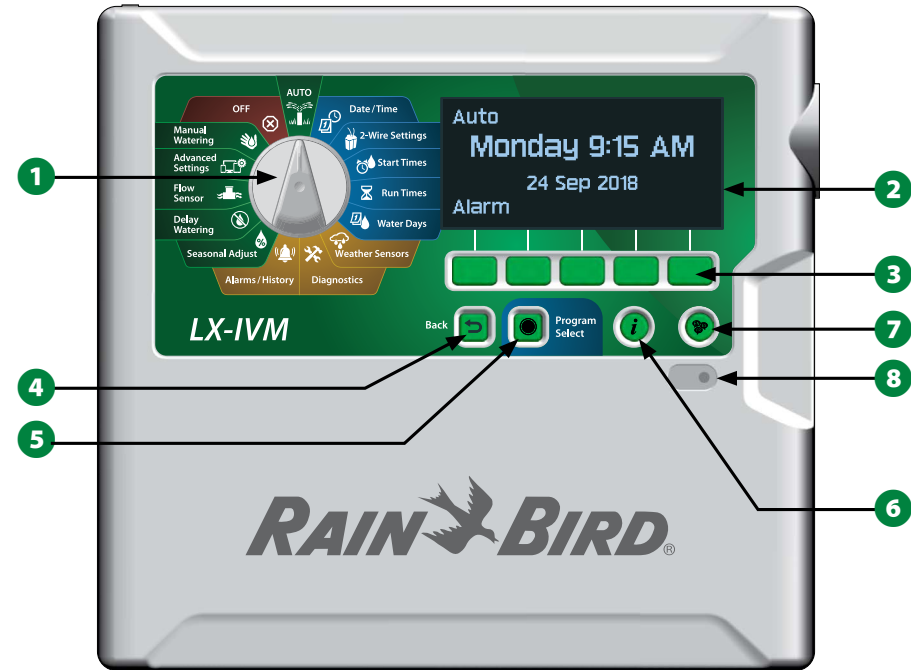

ESP-LXIVM Controller Front Panel Features

2-Wire path Overview

2-Wire path Design

The ESP-LXIVM controller with 2-Wire path has key advantages over traditional controllers that use separate wires for each valve.

- The 2-Wire path design allows DC Latching Valves to be attached at any location, allowing greater design flexibility and greater distances to be supported.
- The LX-IVM controller has connections for up to four separate 2-Wire Paths.
- DC Latching Valves can be managed using up to 6.61 miles (10.63 Km) of wire path, if looped.

Star Pattern

A Star Pattern allows branching as often as necessary without ever looping the wire back to the controller.

This generally allows more design flexibility but at the expense of some distance. The distance from the controller to the farthest IVM Device is known as the critical path; the greatest distance supported with 14 AWG cable in a Star Pattern is 1.65 miles (2.66 Km).

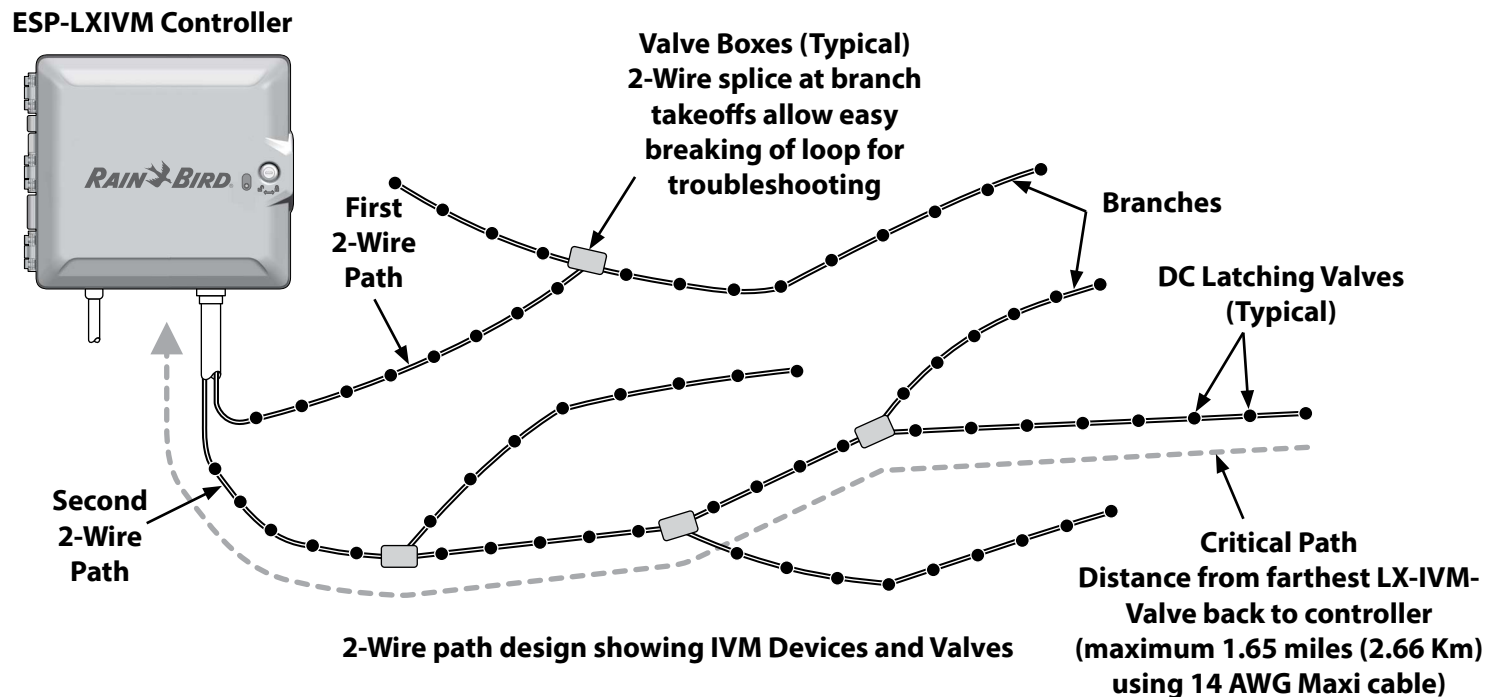

Loop Pattern

A Loop Pattern supports the greatest distance from controller to IVM Devices.

The Loop Pattern requires that the 2-Wire path loop back and return to the controller. The critical path for a Loop design is determined by calculating the distance around the loop to the farthest IVM Device and back to the controller. For both the Star and Loop designs, different distances can be supported with larger gauge cable.

Maximum Critical Path Lengths for 2-Wire Paths					
Nominal Wire Size	Ohms per 1000' or Ohms per Km (per conductor)	Star		Loop	
		Km	Miles	Km	Miles
2.5 mm	7.5 Ohms/Km	3.00	1.86	12.00	7.46
14 AWG	2.58 Ohms/1000'	2.66	1.65	10.63	6.61
12 AWG	1.62 Ohms/1000'	4.23	2.63	16.93	10.52
10 AWG	1.02 Ohms/1000'	6.72	4.18	26.89	16.71

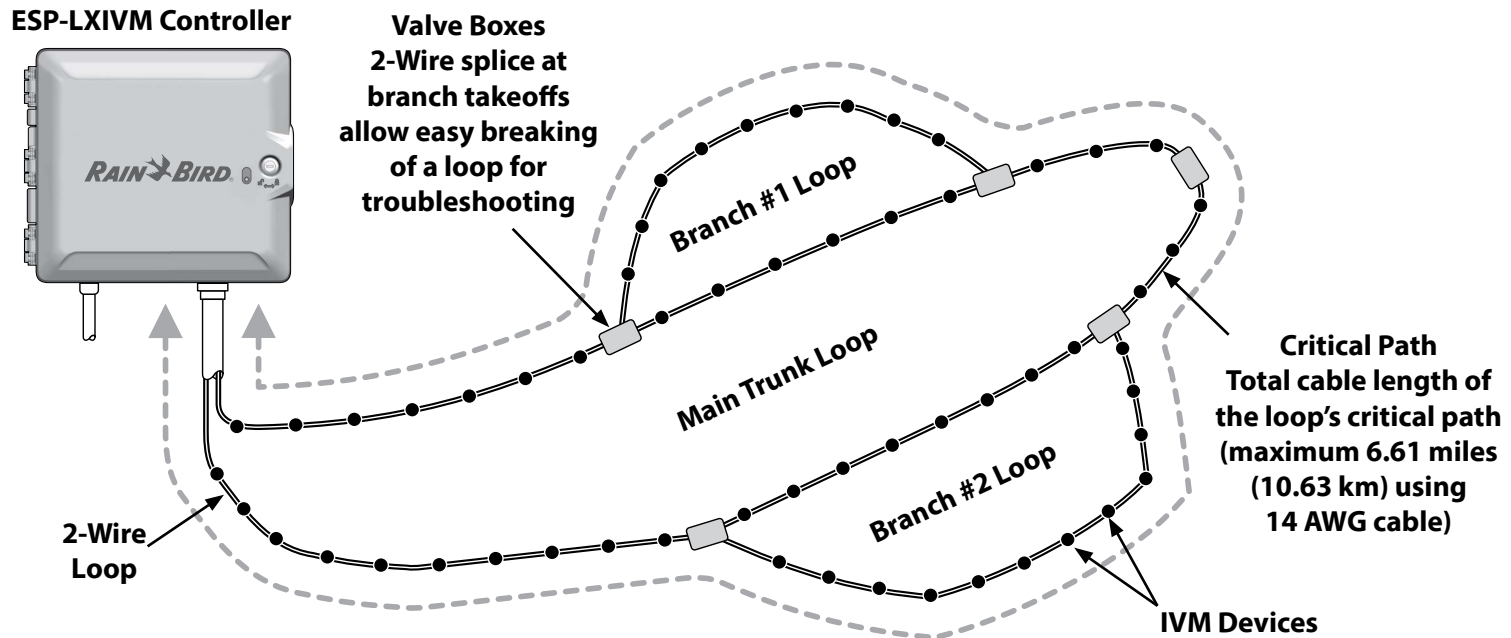

2-Wire Loop Pattern design showing IVM Devices and Valves

2-Wire Devices

LX-IVM 2-Wire Devices attach directly to the 2-Wire path to control valves and/or monitor sensors (weather and flow).

Types of 2-Wire Devices

IVM-SOL Integrated Valve Modules

IVM-SOL is used to control compatible Rain Bird Valves such as PEB, PESB, PGA, BPES and EFB series. IVM-SOL can be used for both station and master valves. Compatible valves are also available with a factory installed IVM-SOL.

IVM-OUT (Output Device)

IVM-OUT 2-Wire control devices can be used to control valves with DC latching solenoids.

IVM-SEN (Sensor Device)

Flow and weather sensors are connected to the 2-Wire path via IVM-SEN 2-Wire devices.

IVM-SD (Surge Device)

The IVM-SD provides surge protection for the ESP-LXIVM controller and the 2-Wire path.

2-Wire Device Addresses

All LX-IVM 2-Wire Devices have a unique five digit address printed on the label of each device for identification on the 2-Wire path.

Local Weather Sensor

A local weather sensor such as a rain shutoff device can also connect directly to the IVM 2-Wire Interface Module inside the controller via a separate wired or wireless connection.

- Both the LX-IVM and LX-IVM Pro support one Local Weather Sensor.

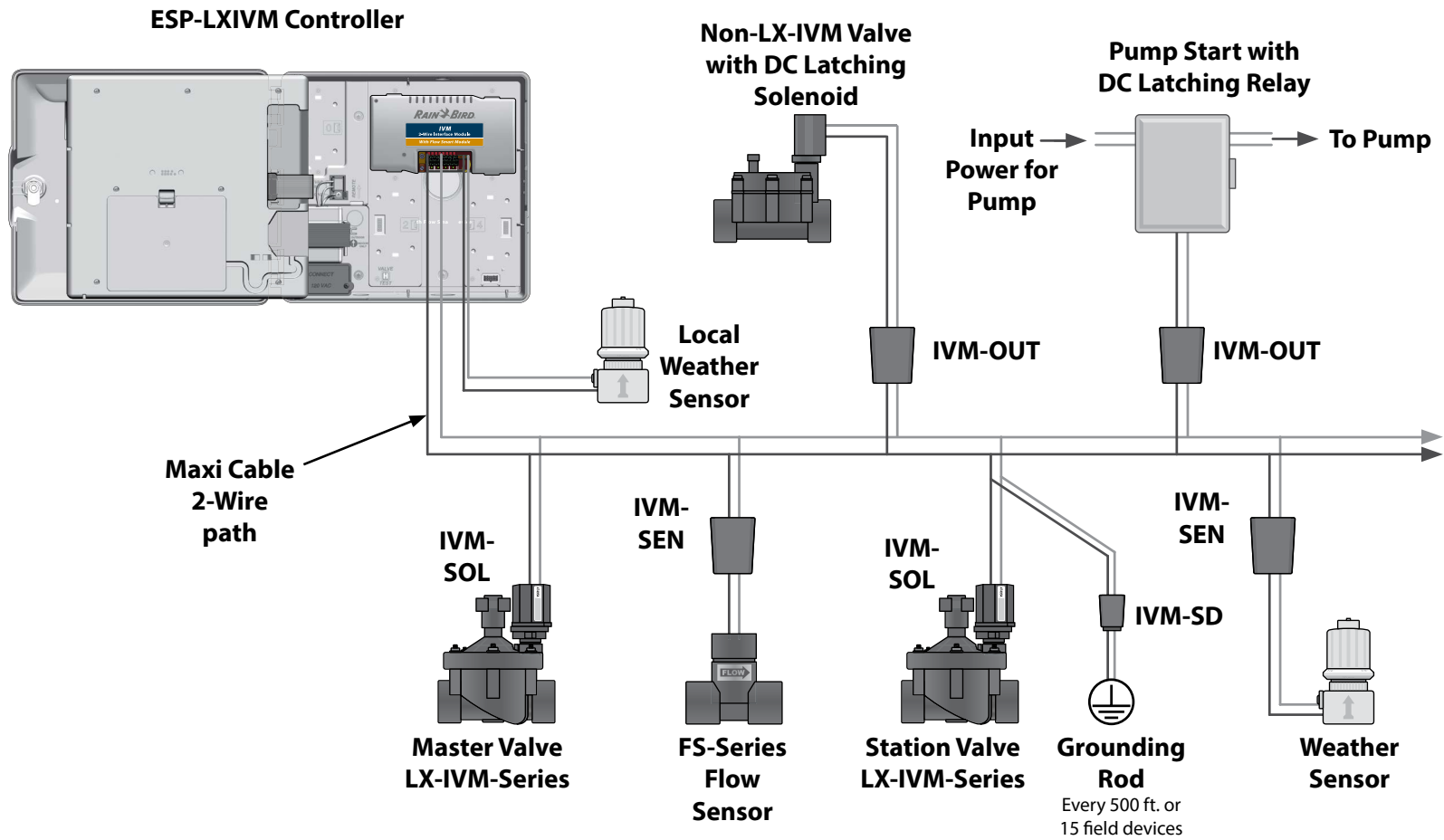

ESP-LXIVM 2-Wire Control System showing IVM Devices connected

Valves (Stations)

Valves, or stations are controlled and operate according to irrigation programs.

The controller is programmed to send signals to an LX-IVM-Valve, which opens and closes on a timed schedule. For example, the controller sends the first LX-IVM-Valve a signal to open, allowing irrigation. When that program is finished, the controller shuts off that valve and sends a signal for the second LX-IVM-Valve to open and so on.

Advanced Station Settings and Features

The ESP-LXIVM has many powerful Advanced station settings, including:

Cycle+Soak

Allows water to be applied to stations intermittently and is useful for locations such as hillsides which can be difficult to irrigate effectively. See "Cycle+Soak™" on page 33 for more details.

Inter Station Delay

Delays the start of the next station in a program after the previous station completes. See "Inter-Station Delay" on page 35 for more details.

SimulStations

Allows you to operate multiple stations at the same time. See "Set SimulStations for Program" on page 36 for more details.

Station Sequencing

Set the sequence in which stations run by Station Number or Station Priority. See "Station Sequencing" on page 36 for more details.

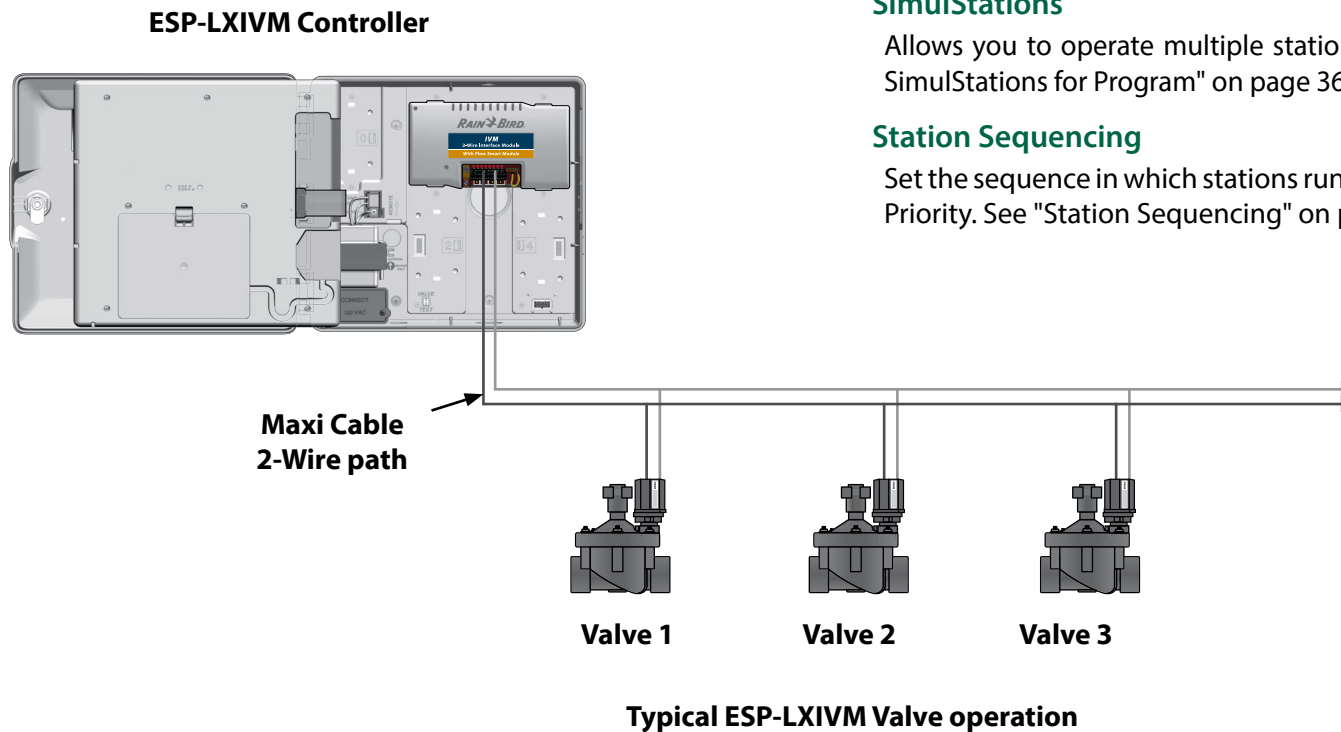

Programming Overview

Programs

The controller opens and closes the ESP-LXIVM-Valves according to a program you set. Each program contains:

Watering Start Times

The time(s) of day when a station is programmed to begin watering; all other stations in the program then follow in sequence. See "Set Watering Start Times" on page 40 for more details.

Station Run Times

The length of time in hours and minutes that each individual station is programmed to run. "Set Station Run Times" on page 41 for more details.

Watering Days

The days of the week or calendar dates on which irrigation is allowed. See "Select Water Days" on page 42 for more details.

Programming Guide

Before you begin programming, fill out the Programming Guide.





2-Wire Device Address Labels

Apply 2-Wire Device barcode labels in the Programming Guide.

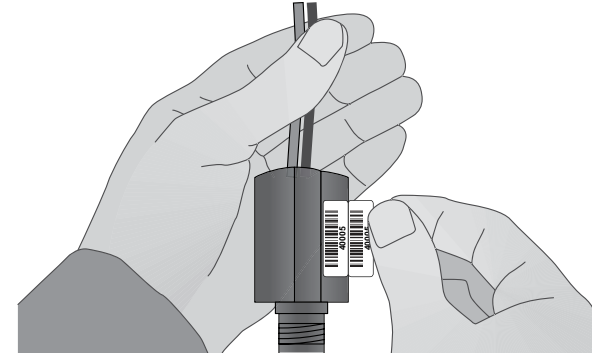
- 1 Carefully peel off the station, master valve, flow or weather sensor device barcode label.



- 2 Apply address labels in the appropriate fields in the Programming Guide.

Station No.	Station 2-Wire Device Address Label	Description
1	 40005	Entry sprays
2	 40006	Color beds

Fill Out the Programming Guide

- 1 Enter information about your system hardware and settings in the appropriate fields on the Programming Guide.

Station No.	Station Run Time	Station Flow Rate	Station Cycle Time
1	10 min.	52	5 min.
2	20 min.	26	10 min.

ENTER INFO

Storing the Programming Guide

- 2 Return the Programming Guide to a permanent, safe location when you're finished working with it. We recommend hanging it on the hook inside the controller cabinet door as shown below.

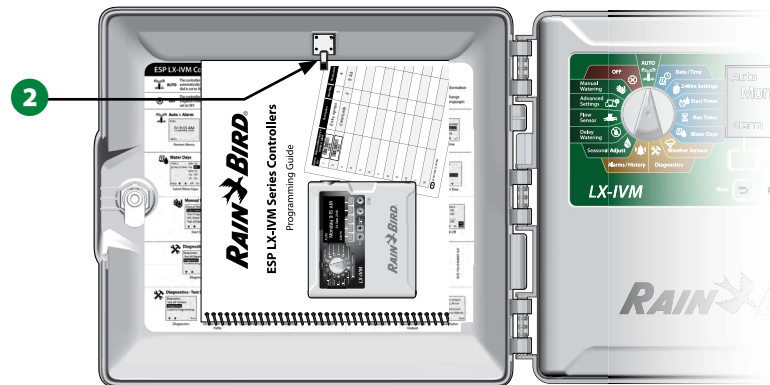

Remote Programming

The ESP-LXIVM controller can be programmed while operating under battery power.

This feature is useful if the controller is installed in an area that is not easily accessible. It also lets you enter program information before installing the controller at the job site. See "Programming Under Battery Power" on page 114 for more details.

Information Button

Press the Information Button to see descriptions of the ESP-LXIVM controller features by dial position.

- 1 Turn the controller dial to the desired dial position, then using the programming keys, navigate to a specific screen.

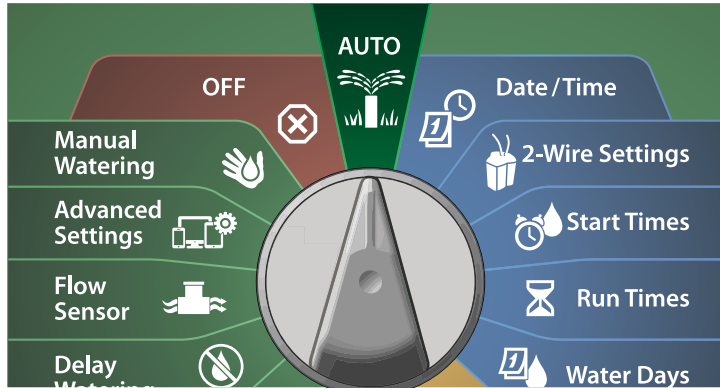

- 2 Press the Information Button.
- 3 A feature description appears on the display.

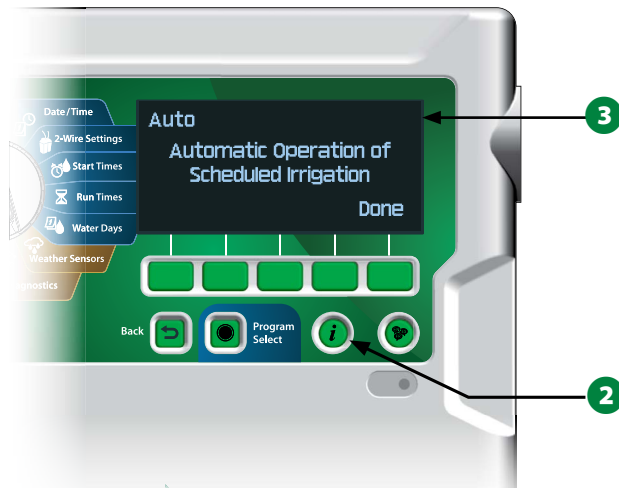

Language Select Button

Press the Language Select Button to change the interface language. Choose from English, Spanish, French, German, Portuguese or Italian.

- 1 Press the Language Button.
- 2 Press the Down Arrow key to select the desired language.



- 3 Press Done when finished.

Programming Checklist

When programming the ESP-LXIVM controller for the first time, it is recommended that you complete the following steps in order.

Set Up Hardware

- Install IVM 2-Wire interface module..... page 108
- Apply 2-Wire Device Labels..... page 17
- Fill out Programming Guide page 18
- Clear program information page 92
- Select language..... page 19
- Set the current date and time page 23
- Set up master valves (optional) page 24
- Set up weather sensors (optional)..... page 28
- Set up stations page 28
- Set up flow sensors (optional)..... page 31
- 2-Wire Mapping.....`

Set Up Programs

- Select program page 39
- Set watering start times page 40
- Select watering days * page 40
- Set station run time(s)..... page 41

* See Watering Cycles dial position for Odd, Odd31, Even and Cyclical watering cycles.

Set Up Programs (Optional)

- Set seasonal adjust..... page 66
- Create a water window..... page 71
- Set up a station delay page 35
- Set up Simulstations..... page 35

Review Setup

- Confirm program page 53
- Test stations page 47
- Check 2-Wire setup page 24
- Check installed modules page 108

Optional Setup

- Check weather sensor status..... page 59
- Schedule calendar days off page 70
- Create a MV manual water window page 98
- Set Cycle+Soak™ page 33
- Set flow units..... page 87
- Activate Flo-Manager® page 82
- Activate FloWatch™ page 83
- Set up High Flow and Low Flow actions page 84
- Set controller to AUTO page 21

AUTO > Alarm

Automatic Operation

AUTO is the normal operating mode.



Turn the controller dial to AUTO

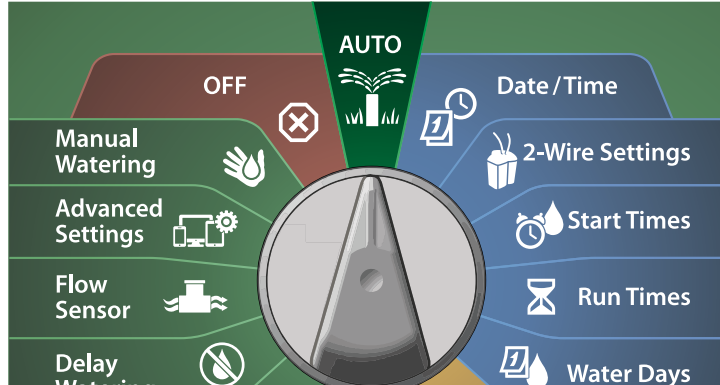

- 1 The Auto screen shows the current day and time.
- 2 When a program is running in AUTO mode, the station number will show on the screen. Press the + or – keys to add or subtract minutes from the run time for the currently running station. To advance to the next station in a program, press the Adv key.

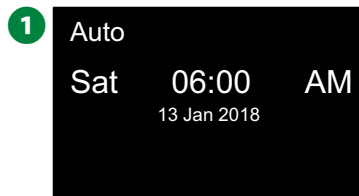

Alarms

An alarm condition can occur when programming omissions or other issues prevent normal irrigation.

Alarm Detected

- 1 When an alarm condition is detected, the red alarm light on the controller front panel will illuminate.

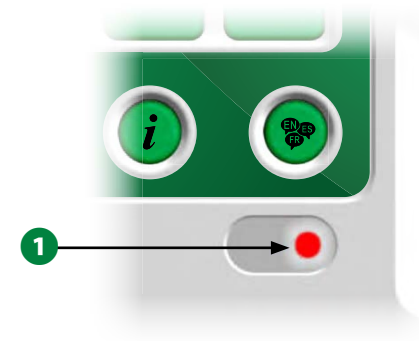

Alarm Conditions



Turn the controller dial to AUTO

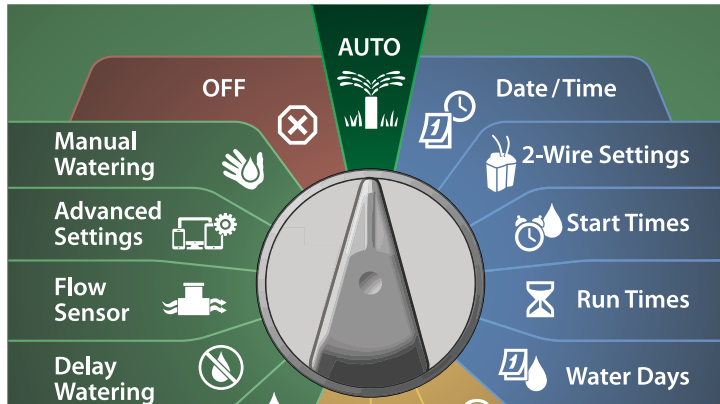

- 1 When an alarm condition is present, the Alarm key label will be present on screen. Press the Alarm key to view alarm details.
- 2 Any present alarm conditions will then be shown. Press the More key to continue to the next page.

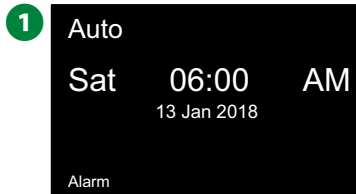

NOTE: Take the appropriate action to address each alarm condition. When all alarms have been addressed, the alarm light on the front panel will no longer be illuminated.

List of Alarm Conditions

Alarm	Condition
No Water Days	There are no water days set in any program.
No Run Times	There are no run times set in any program.
No Start Times	There are no start times set in any program.
No PGM will AUTO Run	There is no program with start times and run times and water days.
Max PGMs Stacked	Max is 8 (equal to the start times).
Flow Alarm	Shows for high or low flow conditions. See "Flow Alarms" on page 61 for more details.
Zero Learned Flow	0 flow is learned for 1 or more stations FloWatch is turned on. See "Set Flo-Manager" on page 81 for more details.
No Two-Wire Module	2-Wire Module is not enumerated.
Invalid Module Installed	One or more of the following is installed: Triac Module, ESPLX-SM75 Module, FSM Module, FSCM Module, ESP-LXD-M50 Module.
All Addresses are Zero	There is no address assigned for any of the four device types.
All paths turned off	All 2-Wire paths have been turned off by the user (remote or at controller).
No AC power	The panel is running on the 9V battery (no AC).
Duplicate addressee	Shows if there are any duplicate addresses for a Station, MV, Weather, or Flow device. Shows up to two duplicates.
Device not responding	Shows if a device is addressed but not responding to ping.
Shorted paths	One or more paths have been automatically turned off due a short being detected.

Date & Time Settings

1 Turn the dial to Date/Time

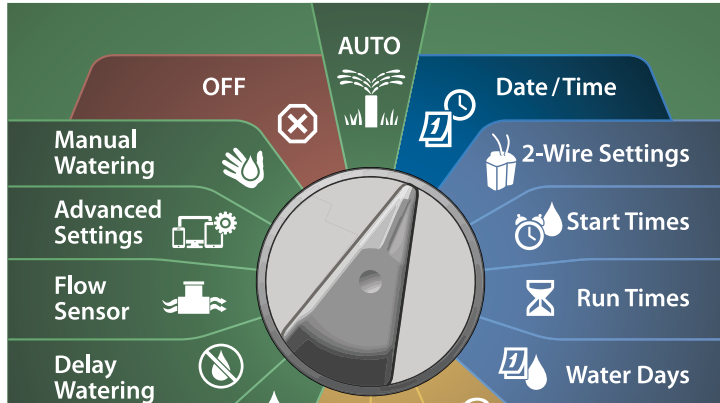

- 1** At the SET DATE AND TIME screen, press the + and – keys to set the current hour, then press the Right Arrow key.
 - Press and HOLD keys to accelerate settings.
- 2** Press the + and – keys to set the current minute, then press the Right Arrow key.

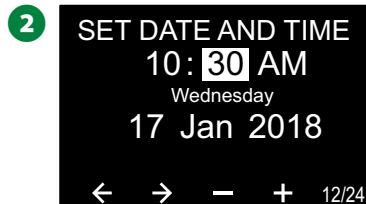
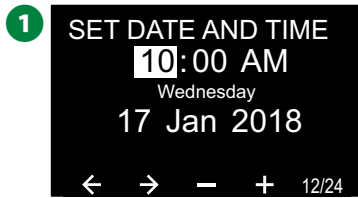

- 3** Press the + or – keys to set AM or PM, then press the Right Arrow key.

NOTE: The date will automatically updated once the current day, month and year entered.

- 4** Press the + and – keys to set the current day, then press the Right Arrow key.

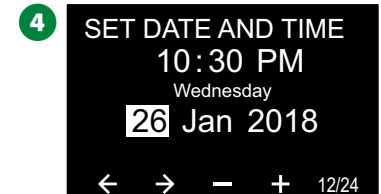
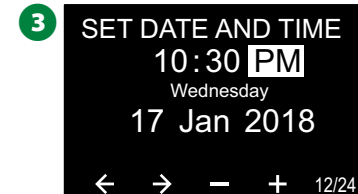

- 5** Press the + and – keys to set the current month, then press the Right Arrow key.

- 6** Press the + and – keys to set the current year, then press the Right Arrow key.

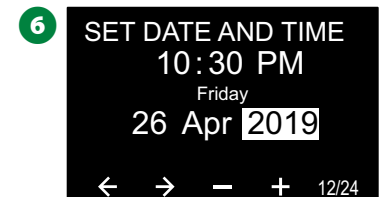
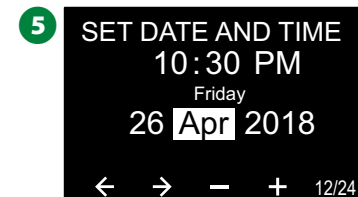

- 7** Press the 12/24 key to change the clock format from American standard to Military standard.

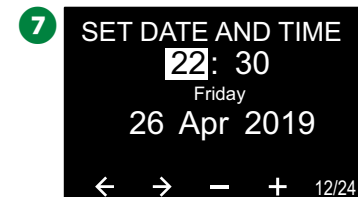

2-Wire Setup

Master Valves

Master Valves Setup tells the ESP-LXIVM controller what types of master valves (MVs) are used by your irrigation system.

- The LX-IVM supports up to 5 Master Valves (or pump start relays) and the LX-IVM Pro supports up to 10.
- LX-IVM-Valves can be configured as either a Normally Open Master Valve (NOMV) or a Normally Closed Master Valve (NCMV).

 NOTE: Pump start relays are set up in the controller as Master Valves. For more details, see the ESP-LXIVM Field Device Installation Guide that came with the controller.



Turn the dial to 2-Wire Settings

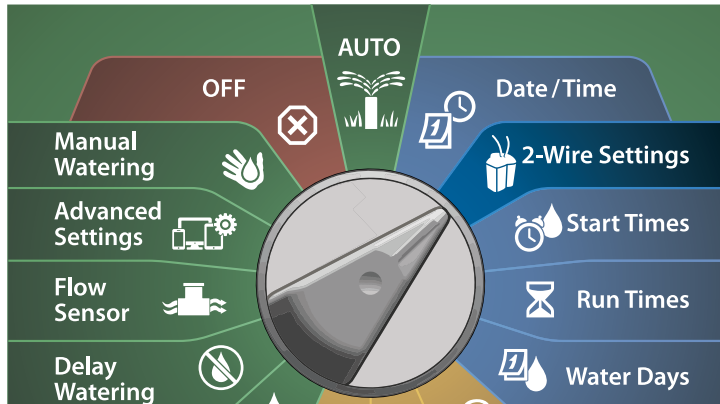

- 1 At the 2-WIRE SETUP screen, with Master Valves selected, press Next.
- 2 At the Master Valve Setup screen, press the + and – keys to set the desired Master Valve (from 1-10), then press the Right Arrow key.

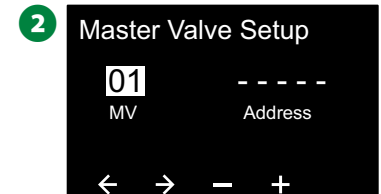
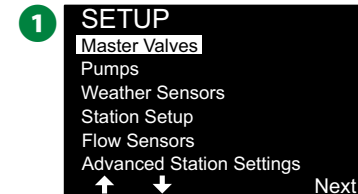

- 3 Press the + and – keys to set the desired Master Valve Address. Press the Arrow keys to navigate between the number setting fields. Once all fields are entered, the Next key appears; press Next.

 NOTE: An alarm will show if a duplicate 2-Wire Device address is entered for more than one sensor. See "Alarms" on page 21 for more details.



Master Valve

The LX-IVM supports 3 types of Master Valves.

Normally Closed (most common): Only open when assigned stations operate.

Normally Open: Only close for FloWatch shutdown and when cycling.

Normally Open IVM Valves: Turns any IVM valve into a normally open master valve, and only closes for FloWatch shutdown and when cycling.

- 1 At the Master Valve Setup screen, press the + and – keys to select the valve type, then press next.
- 2 At the FloZone assignment screen, press the + and – keys to associate the MV with the appropriate FloZone, then press Next.

 NOTE: A FloZone may have multiple master valves as it's source(s), but an MV can only be assigned to a single FloZone.

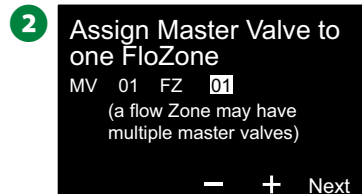
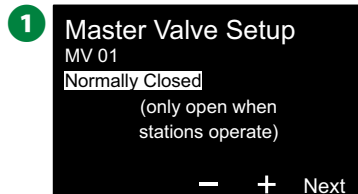

- 3 The Shared MVs screen shows the other MVs associated with the selected FloZone. Press the Arrow keys to select the desired FloZone, then press Next.
- 4 A review shows that settings for the MV. Press the Done key to complete the Master Valve setup. Or else press the Back button to go back and change settings if desired.

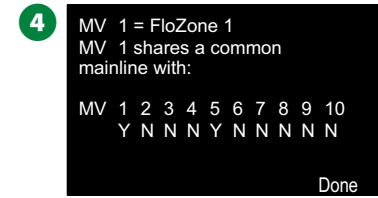
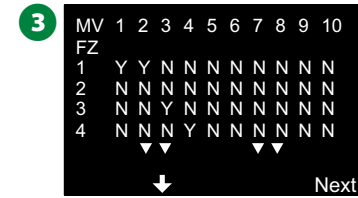

-  Repeat this process to set up additional master valves. Be sure to note each MV in your Programming Guide for future reference.

NOMV Cycling (Normally Open Master Valves Only)

In order to maintain the continuity of NOMV diaphragms and solenoids, the controller can be programmed to cycle them closed for a minute.

NOTICE

Each NOMV will be cycled closed for 60 seconds on the first day of each month. Irrigation is suspended when the NOMV is shut, so choose a time when no irrigation is scheduled.

- 5 At the Master Valve Setup screen, press the + and – keys to select Normally Open, then press Next.
- 6 At the NOMV Cycling confirmation screen, press Next to continue.

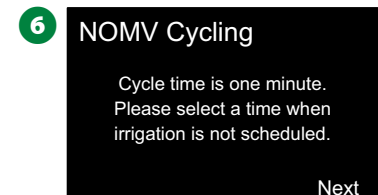
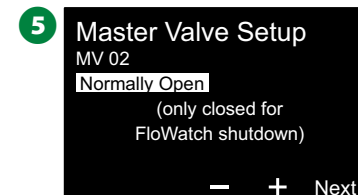

- 7 Press the + and – keys to select Yes for NOMV Cycling, then press the Right Arrow key.

8 Press the + and – keys to set the Cycle Time, then press Next.



9 At the FloZone assignment screen, press the + and – keys to associate the MV with the appropriate FloZone, then press Next.

NOTE: A FloZone can have multiple MVs as its source(s), but a MV can only be assigned to a single FloZone.

10 The Shared MVs screen shows the other MVs associated with the selected FloZone. Press the Arrow keys to scroll the list of FloZones, then press Next to continue.

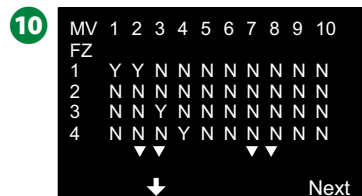
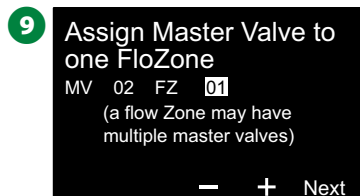

11 A review screen shows the settings for the MV.

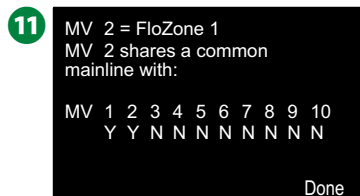

Repeat this process to set up additional master valves. Be sure to note each MV on your Programming Guide for future reference.

Pumps

Pump Setup tells the ESP-LXIVM controller that pumps are used in your irrigation system.

- 1 At the SETUP screen, select Pumps, then press Next.
- 2 At the Pumps Setup screen, press the Arrow keys to select the desired Pump Station (PS), then press Next again.
- 3 Press the + and – keys to set the desired Pump Address. Press the Arrow keys to navigate between the number setting fields. Once all fields are entered, the Next key will appear; press it to continue

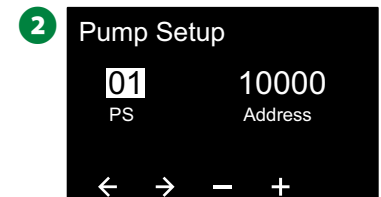
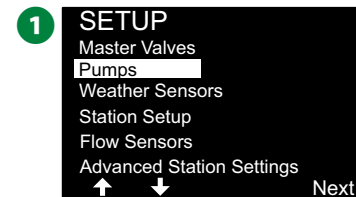

4 A confirmation screen will appear, displaying the Master Valve and FloZone the Pump was assigned to, press Done.

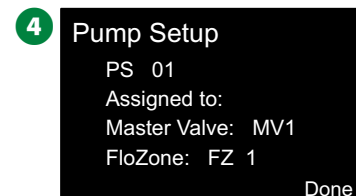

Repeat this process to set up additional pumps. Be sure to note each on your Programming Guide for future reference.

NOTE: Pumps are associated with the corresponding Master Valve of the same number (e.g. PS1 will be assigned to MV1). For details on combining multiple pumps into a single FloZone see "Master Valve" on page 25

Weather Sensors

Weather Sensor Setup tells the ESP-LXIVM controller what types of weather sensors are used by your irrigation system.

Weather sensors are not required for the LX-IVM controller, but they increase functionality by allowing irrigation control based on changing weather conditions.

- The LX-IVM supports three 2-Wire Device weather sensors and the LX-IVM Pro supports seven.

Sensor Types

Type	Action
Rain	Prevent
Wind	Pause
Freeze	Pause
Soil Moisture	Prevent
Custom Pause	Pause
Custom Prevent	Prevent

Set Up 2-Wire Device Weather Sensors



Turn the dial to 2-Wire Settings

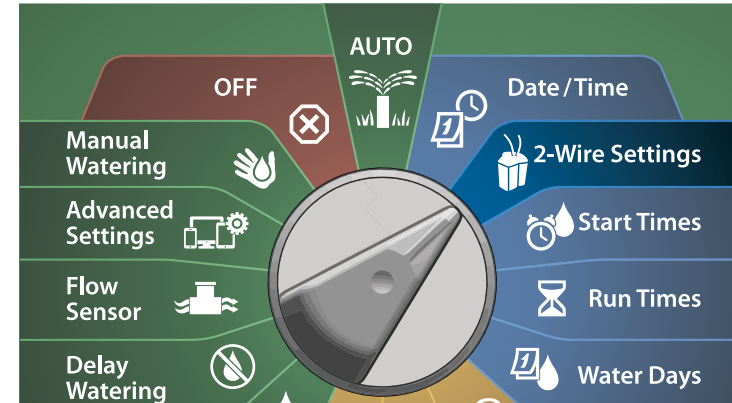

- 1 At the 2-WIRE SETUP screen, press the Down Arrow key to select Weather Sensors, then press Next.
- 2 At the Weather Sensor Setup screen, press the + and – keys to set the desired Weather Sensor (from 1-7), then press the Right Arrow key.

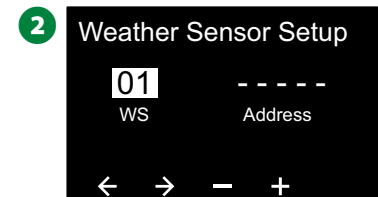
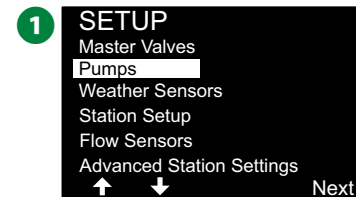

- 3 Press the + and – keys to set the desired Sensor Address. Press the Arrow keys to navigate between the number setting fields. Once all fields are entered, press the Next key.

 NOTE: An alarm will show if a duplicate 2-Wire Device address is entered for more than one sensor. See "Alarms" on page 21 for more details.

- 4 Press the + and – keys to select the type of weather sensor (Rain, Freeze, Wind, Soil Moisture, Custom Pause, or Custom Prevent), then press the Down Arrow key to continue.

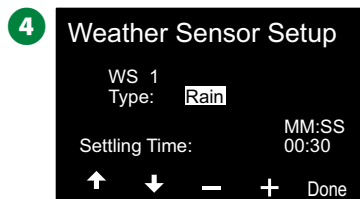
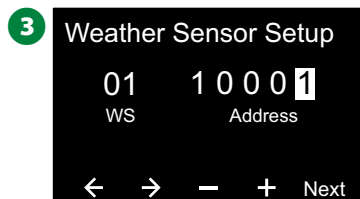

- 5 Press the + and – keys to set the desired settling time.



 NOTE: Settling time is how long a weather condition must last before the controller takes action. For example, if a freeze sensor has a 5 minute settling time then the temperature would have to remain below the sensor's threshold set point for 5 minutes before irrigation is paused. Settling time can be set for immediate (0 seconds) or up to 10 minutes long.

-  Repeat this process to set up additional weather sensors. Be sure to note each weather sensor on your Programming Guide for future reference.

Custom Pause Sensors

When a weather condition becomes true, a Custom Pause sensor will stop irrigation and also stop the irrigation timer. When the condition becomes false again, irrigation will start exactly where it left off.

For example, if a station is set to irrigate for 20 minutes but is shut down by a Pause sensor after only 5 minutes; when the weather condition becomes false again and after Resume, that station will receive the full remaining 15 minutes of irrigation left on the timer.

Custom Prevent Sensors

When a weather condition becomes true, a Custom Prevent sensor will stop irrigation but allow the irrigation timer to continue to run. Then when the condition becomes false again, irrigation will resume at the same time had the weather condition never occurred.

For example, if a station is set to irrigate for 20 minutes but is shut down by a Prevent sensor after only 5 minutes, if the condition becomes false again after 10 minutes then that station will only receive the remaining 5 minutes of irrigation left on the timer.

Local Weather Sensor

Both the LX-IVM and IVM Pro support one local weather sensor. See "Connect Local Weather Sensors" on page 46 for more details.

Station Setup

Station Setup tells the ESP-LXIVM controller how many and what type of stations are used by your irrigation system.

 NOTE: Before setting up stations, follow the previous instructions to set up master valves and weather sensors (if present).



Turn the dial to 2-Wire Settings

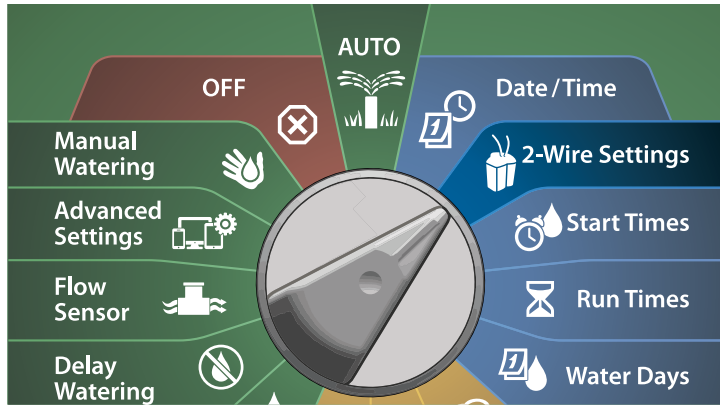

- 1 At the 2-WIRE SETUP screen, press the Down Arrow key to select Station Setup, then press Next.
- 2 At the Station Setup screen, press the + and – keys to set the desired Station from 1 to 60 (240 for LX-IVM Pro), then press the Right Arrow key.

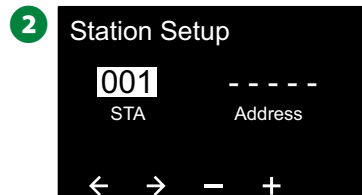
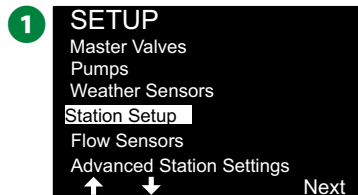

- 3 Press the + and – keys to set the desired Station Address. Press the Arrow keys to navigate between the number setting fields. Once all fields are entered, press the Next key.

 NOTE: An alarm will show if a duplicate 2-Wire Device address is entered for more than one sensor. See "Alarms" on page 21 for more details.

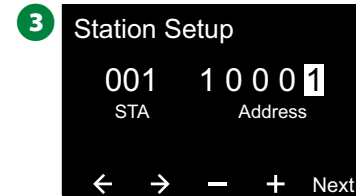

Set Priority

Each station can be set to high, medium, low or Non-irrigation.

The controller will run all high priority stations first, then all medium and finally all low priority, regardless of the station's program settings.

- 1 At the Station Setup screen, with Set Priority selected, press Next to continue.

 NOTE: Station Priorities are only used when Station Sequencing is set to Sequence by Station Priority. If you're using the default Sequence by Station Numbers, then skip the next step by pressing Next.

- 2 Press the + and – keys to select the priority type. Each station can be set to High, Medium, Low or Non-irrigation.

 NOTE: Non-irrigation stations such as fountains and landscape lighting receive priority to always run, regardless of weather conditions.

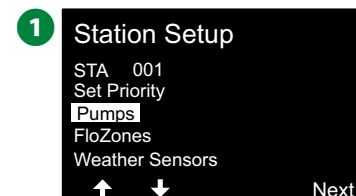

Assign Pumps by Station (Optional)

By default, pumps activate for all stations in the assigned FloZone. However, you can define pump behavior by station by following the steps below.

- 1 At the SETUP screen, select Station Setup, then press Next.
- 2 At the Station Setup screen, press the Arrow keys to select the desired Station (STA), then press Next again.



- 3 At the next Station Setup screen, press the Arrow keys to navigate to Pumps, then press Next again.
- 4 At the Assign Pumps screen, press the + and - keys to associate the Station with the appropriate Pumps, then press Done to confirm.



 NOTE: A Pump Station is assigned to a single Master Valve and FloZone. You will only be able to make changes to Pump Stations with common FloZone assignment as the selected station. The image below shows a single FloZone with two pumps.

FloZones

- 1 At the Station Setup screen, press the Down Arrow key to select FloZones, then press Next.
- 2 At the Assign FloZone screen you can assign stations to FloZones. Press the + and - keys to view and select from available FloZones.





 NOTE: If you have already set up your MVs and FloZones, the MV assignments for the currently selected FloZone will be shown in the bottom portion of the screen. See "Master Valves" on page 24 for more details.

Weather Sensors

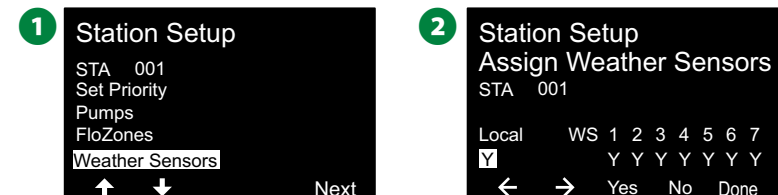
- 1 At the Station Setup screen, press the Down Arrow key to select Weather Sensors, then press Next.
- 2 At the Assign Weather Sensors screen you can assign stations to obey a particular weather sensor. Press the + and - keys to set Y, for weather sensors which that station should obey, or set N, for sensors which that station should ignore. Press the Arrow keys to navigate between the number setting fields.



 **NOTE:** All weather sensors, both LX-IVM-Sensor 2-Wire connected and local, can be turned on (Active) or off (Bypassed) using the Weather Sensors switch on the controller front panel. See "Weather Sensors" on page 28 for more details.

 Repeat this process to set up additional sensors.

Flow Sensors

Set Up Rain Bird Flow Sensor

Flow Sensor Setup tells the ESP-LXIVM controller what flow sensors are used by your irrigation system.

Flow sensors are not required for the LX-IVM controller, but they add functionality by alerting you to abnormally high or low flow rates and even shutting down affected MVs or stations if flow rates exceed set thresholds.

- The LX-IVM can support up to five flow sensors and the LX-IVM Pro can support up to 10.

 **Turn the dial to 2-Wire Settings**

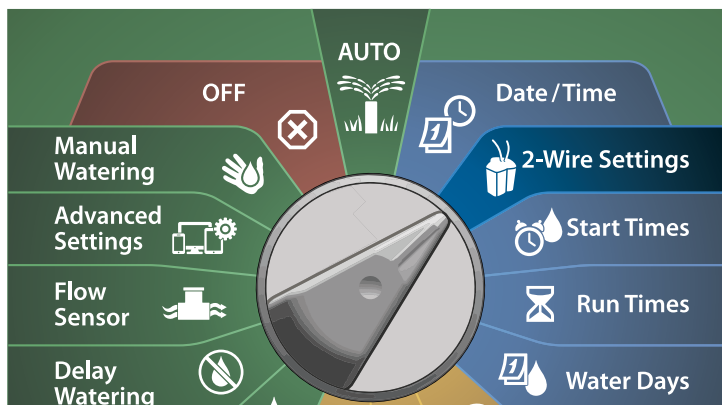

- 1 At the 2-WIRE SETUP screen, press the Down Arrow key to select Flow Sensors, then press Next.
- 2 At the Flow Sensor Setup screen, press the + and – keys to set the desired Station (from 1 to 240), then press the Right Arrow key.

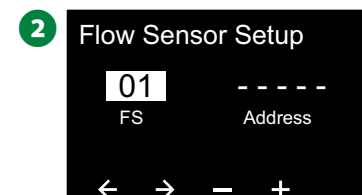
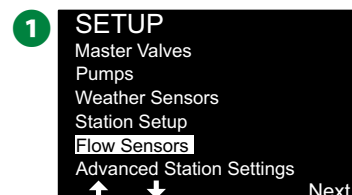

- 3 Press the + and – keys to set the desired Flow Sensor Address. Press the Arrow keys to navigate between the number setting fields. Once all fields are entered, press the Next key.

 **NOTE:** An alarm will show if a duplicate 2-Wire Device address is entered for more than one sensor. See "Alarms" on page 21 for more details.

- 4 Press the + and – keys to select the type of the flow sensor model that you're using, then press Next.

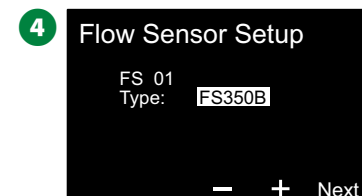
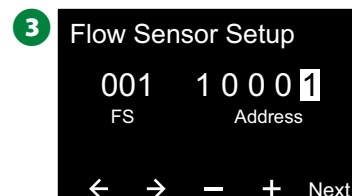

 **NOTE:** The FS350B and FS350SS flow sensor type require the inside pipe diameter to be configured.

- 5 If necessary, use the + and – keys to set the inside pipe diameter.
- 6 A review shows that settings for the Flow Sensor.

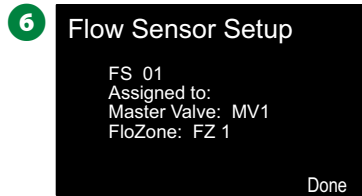
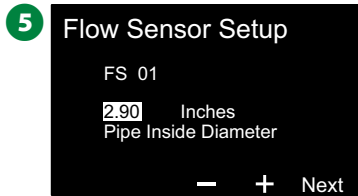

Repeat this process to set up additional flow sensors. Be sure to note each flow sensor on your Programming Guide for future reference.

Set Up Custom Flow Sensor



Turn the dial to 2-Wire Settings

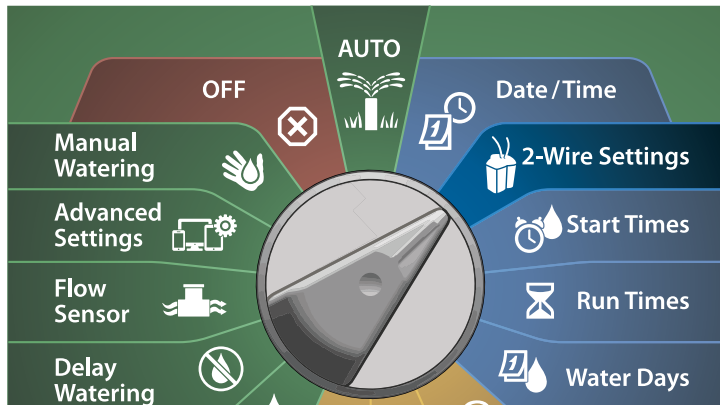

- At the 2-WIRE SETUP screen, press the Down Arrow key to select Flow Sensors, then press Next.
- At the Flow Sensor Setup screen, press the + and – keys to set the desired Sensor number from 1-10.
 - The LX-IVM can support up to five flow sensors and the LX-IVM Pro can support up to 10.

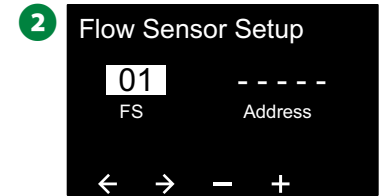
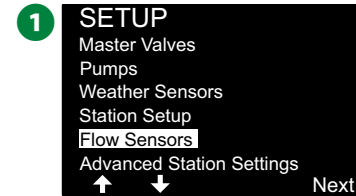

- Press the + and – keys to set the desired Sensor Address. Press the Arrow keys to navigate between the number setting fields. Once all fields are entered, press the Next key.

NOTE: An alarm will show if a duplicate 2-Wire Device address is entered for more than one sensor. See "Alarms" on page 21 for more details.

- Press the + and – keys to select Custom, then press Next.

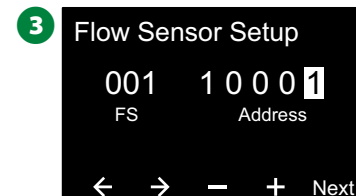

- Press the + and – keys to set the flow sensor K Factor. Press the Arrow keys to navigate between the number setting fields.
- Continue pressing the Right Arrow key to select Offset. Press the + and – keys to set the Offset number, then press Next.

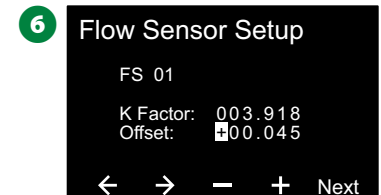
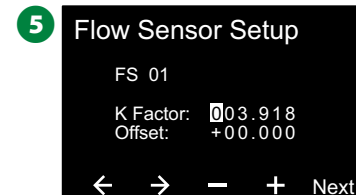

- The Master Valve that is assigned to the flow sensor is shown, and each assigned FloZone is shown below the MV field.

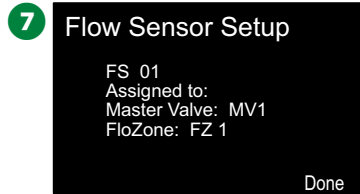

- Repeat this process to set up additional custom flow sensors. Be sure to note each flow sensor on your Programming Guide for future reference.

Advanced Station Settings

Cycle+Soak™

The ESP-LXIVM controller Cycle+Soak feature allows water to be applied to stations intermittently.

This can apply to any station and is useful for locations such as hill-sides which can be difficult to irrigate effectively.

Cycle+Soak consists of two settings:

- Cycle time:** How long a station will run before soaking.
- Soak time:** How long irrigation is paused before applying another cycle.

For example, a station can be set up to receive 15 minutes of irrigation in three 5 minute cycles, with two 10 minutes periods of soak time in between waterings.

- NOTE:** Cycle+Soak settings apply to stations no matter which programs it may be used in.



Turn the dial to 2-Wire Settings

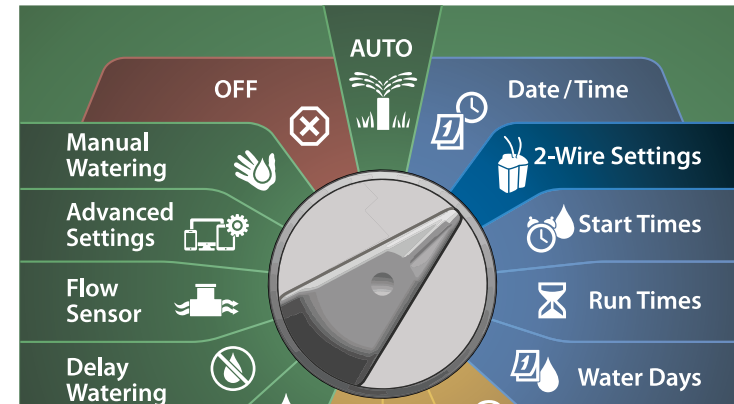

- At the 2-WIRE SETUP screen, press the Down Arrow key to select Advanced Station Settings, then press Next.
- At the Advanced Station Settings screen, with Cycle & Soak selected, press Next.

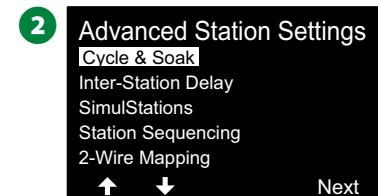
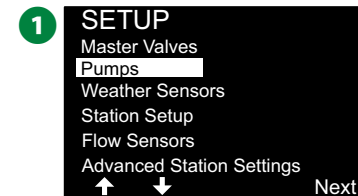

3 At the Cycle & Soak screen, press the + and – keys to set the desired station number, then press the Right Arrow key.

4 Press the + and – keys to set the Cycle time (between 1-60 minutes), then press the Right Arrow key.

- Press and HOLD keys to accelerate settings.

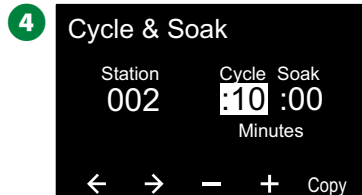
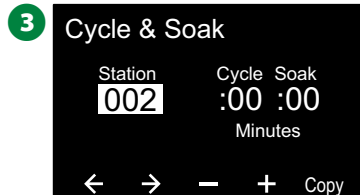

5 Press the + and – keys to set the Soak time (between 1-60 minutes).

- To cancel Cycle+Soak on a station, set both Cycle and Soak to 0.

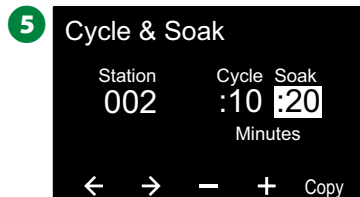

NOTE: Consider using short Soak times, particularly if your watering schedule or Water Window is short. Long delay times could prevent scheduled irrigation from completing prior to the end of the Water Window.

NOTE: The controller is designed to allow additional stations in the irrigation queue to run during the soak time for Cycle+Soak stations.

Repeat this process to set up Cycle+Soak on other stations.

Copy Station To Station

This feature copies the Cycle+Soak™ Programming from one station to other stations.



Turn the dial to 2-Wire Settings

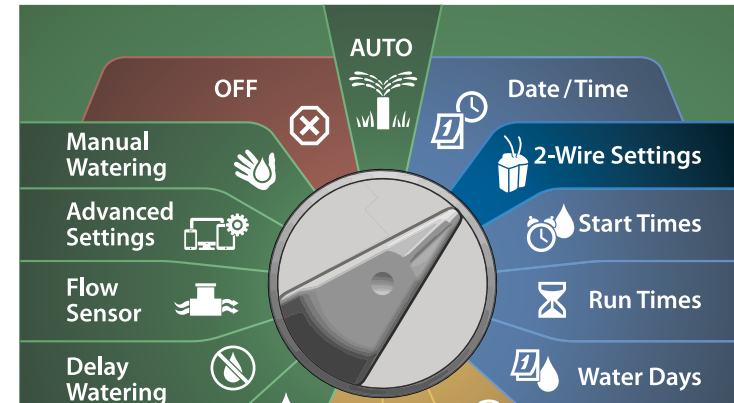

1 At the Cycle+Soak screen, press the Copy key.

2 At the Copy screen, use the <> key to navigate between the number setting fields. Press the + and – keys to set the desired starting and ending station numbers. Press the ✓ key to copy the station data, or press the ✕ key to cancel.

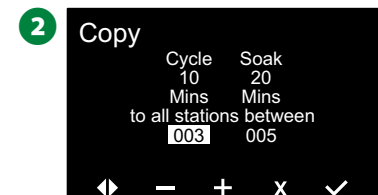
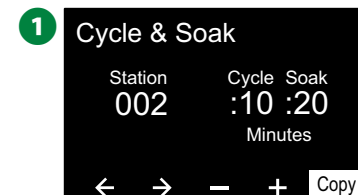

- 3 A confirmation screen shows the process is complete.

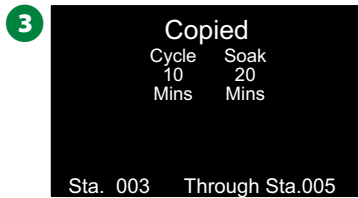

Inter-Station Delay

The ESP-LXIVM controller can be programmed to include a delay between stations.

For example, if you set a one minute delay, station 1 will run until finished, followed by a one minute delay. Then station 2 will run, followed by another one minute delay, and so on.



Turn the dial to 2-Wire Settings

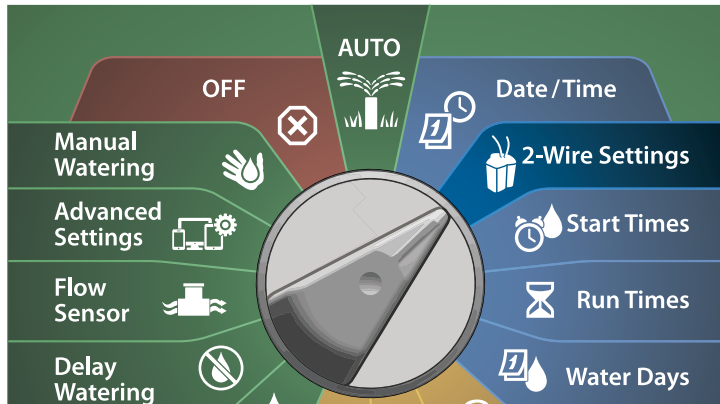

- 1 At the Advanced Station Settings screen, press the Down Arrow key to select Inter-Station Delay, then press Next.
- 2 At the Delay Between Stations screen, press the + and – keys to set the time delay (from 00:01 second to 60:00 minutes).
 - Press and HOLD keys to accelerate settings.
 - To clear an Inter-station Delay on that station, set to 00:00

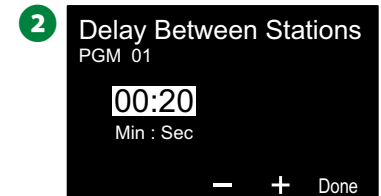
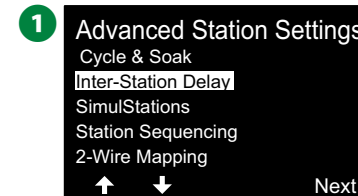

- NOTE: Consider using short Inter-station Delay times, particularly if your watering schedule or Water Window is short. Long delay times could prevent scheduled irrigation from completing prior to the end of the Water Window.
- Change the Program Select switch and repeat this process to set Inter-station Delay for other programs as desired.

SimulStations

The ESP-LXIVM controller can be set to operate multiple stations simultaneously.

You can set the maximum number of stations per program that are allowed to run. This can be beneficial for systems with a large water source and to help ensure watering is completed in the water window.

CAUTION

The LX-IVM can run 8 stations concurrently and the LX-IVM Pro can run 16 concurrent. Many irrigation systems do not have sufficient hydraulic capacity to accommodate such a load.

SimulStations can be used to control the maximum number of stations per program or for the entire controller. But a better alternative would be to enable Flo-Manager® and set program-level SimulStations to a fairly high number. This will allow Flo-Manager® to provide maximum irrigation based on your system's hydraulic capacity. See "Set Flo-Manager®" on page 81 for more details.

Set SimulStations for Program



Turn the dial to 2-Wire Settings

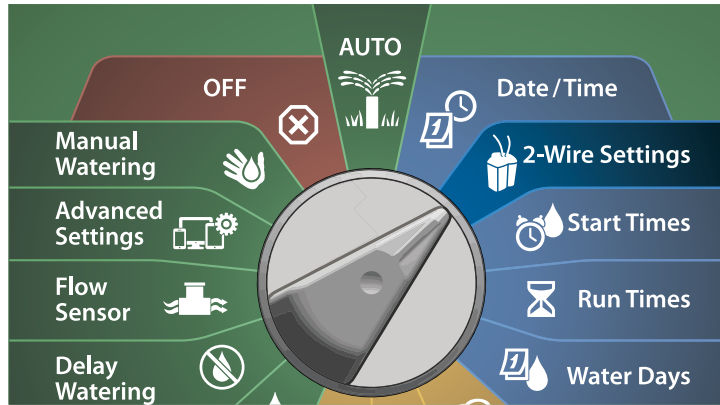

- 1 At the Advanced Station Settings screen, press the Down Arrow key to select SimulStations, then press Next.
- 2 At the SimulStations screen, press the + and – keys to set the number of Irrigation stations (from 1 - 240).

 NOTE: There are two types of the SimulStations (Global and PGM). Press the Arrow keys to navigate between the number setting fields.

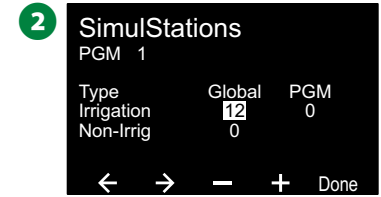
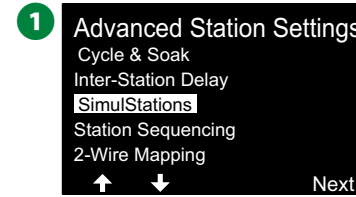

- 3 Press the Right Arrow key to continue to the Non-irrigation station. Press the + and – keys to set the desired number (from 1 to 16).



-  Change the Program Select switch and repeat this process to set the Maximum Number of Stations for other programs as desired.

Station Sequencing

Allows you to optimize water windows by controlling the sequence in which stations can run.

Choose from 2 methods:

1. Sequence by Station Number - (system default).
2. Sequence by Station Priority - required when using Flo-Manager® (LX-IVM Pro only). This option decreases the overall time required to complete watering when operating multiple stations simultaneously.

Station Sequencing by Station Number (Default)

Stations will operate in the following order:

1	Station number	LX-IVM has a capacity of 60 stations. LX-IVM Pro has a capacity of up to 240 Stations.
2	Program assignment	LX-IVM has 10 independent Programs available. LX-IVM Pro has 40 independent Programs available.

NOTICE

Non-irrigation priority stations will always be selected to operate first.

Station Sequencing by Station Priority

Stations will operate in the following order:

1	Station priority	Non-Irrigation > High > Medium > Low
2	Station run time	Longest run time > shortest run time
3	Station number	LX-IVM has a capacity of 60 stations. LX-IVM Pro has a capacity of up to 240 Stations.
4	Program assignment	LX-IVM has 10 independent Programs available. LX-IVM Pro has 40 independent Programs available.

NOTICE

If Flo-Manager® (LX-IVM Pro only) is turned ON, then the default Station Sequencing setting is Sequence by Station Priorities. To select Station Sequencing by Station Number, Flo-Manager® must first be turned OFF. See "Set Flo-Manager®" on page 81 for more details.



Turn the dial to 2-Wire Settings

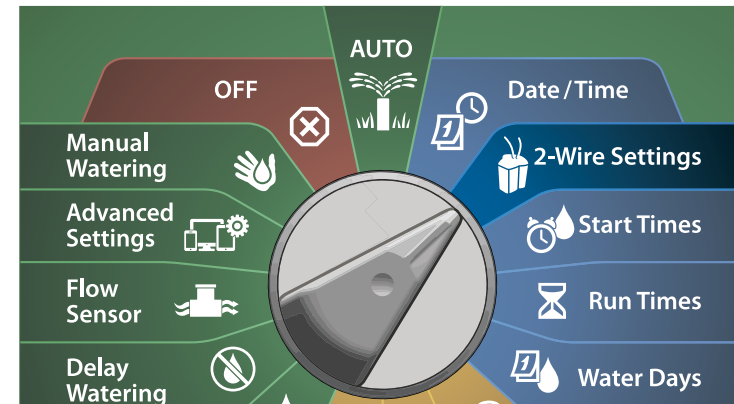

- 1 At the Advanced Station Settings screen, press the Down Arrow key to select Station Sequencing, then press Next.
- 2 At the Station Sequencing screen, press the + and – keys to set Station Sequencing by either Station Numbers or Station Priorities, as desired.

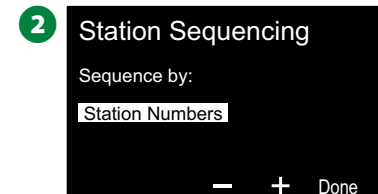
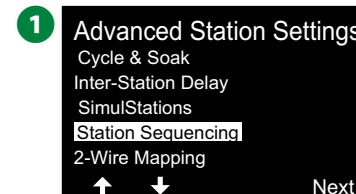

 **NOTE:** When Station Sequencing is set to Sequence by Station Priorities, you can still manually operate stations in station number sequence using the Test All Stations option from the Manual Watering dial position. See "Test All Stations" on page 100 for more details.

2-Wire Mapping

2-Wire mapping identifies the wire path (one of four) that the device is connected to. This could be helpful for Diagnostics.

For example, if you run "List Not responding" you will get a list of stations not communicating along with the wire path they are connected to. If they are all in the same wire path, it could help isolate the cause.

 **NOTE:** 2-Wire mapping is not mandatory and not doing so will not stop irrigation functions.



Turn the dial to 2-Wire Settings

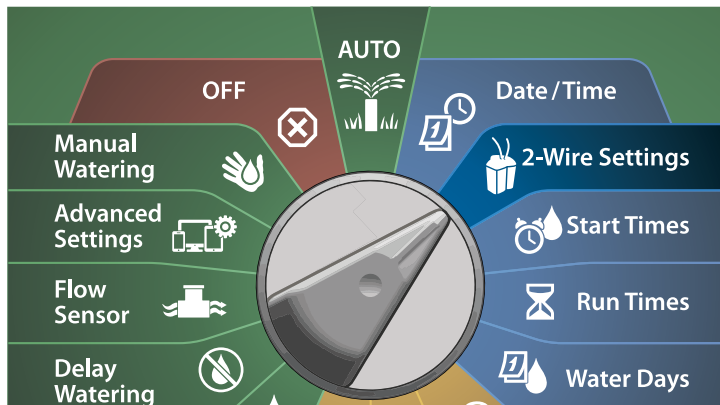

1 At the Advanced Station Settings screen, press the Down Arrow key to select 2-Wire Mapping, then press Next.

2 At the 2-Wire Device Mapping screen, press the + and – keys to set the desired hour (from 0 to 23), then press the Right Arrow key.

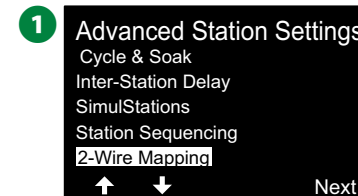

3 Press the + and – keys to set the desired minute (from 1 to 59), then press Next.

4 At the confirmation screen, press Start to begin Device Mapping.

 **NOTE:** All irrigation is disrupted during the mapping process.

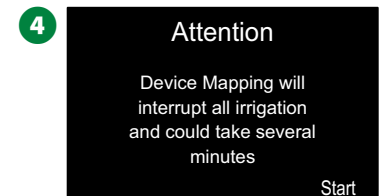
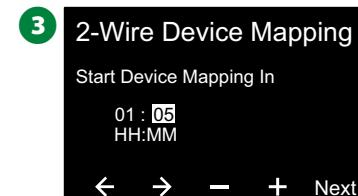

5 A confirmation screen shows the process is set to run.

Basic Programming

Program Select Button

Begin programming by pressing the Program Select button.

- The LX-IVM has 10 independent Programs available and the LX-IVM Pro has 40 independent Programs available.

Multiple programs allow you to set watering schedules to meet different requirements for plant materials, soils, slopes, and shady or sunny areas. Programs can operate simultaneously with the only limitation being the number of stations you program to run simultaneously.

Select Program

- 1 On the controller front panel, press the Program Select + Key to begin programming.

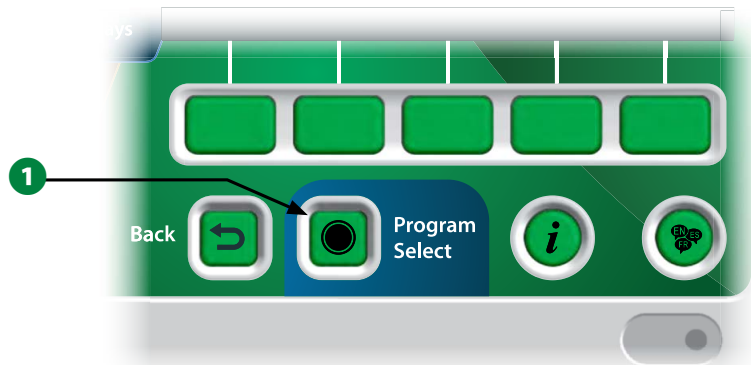

- 2 At the PROGRAM SELECT screen, Press the Arrow keys to select a Program.

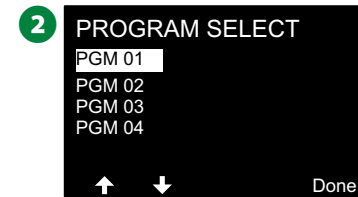

-  NOTE: When programming the controller, any program-specific information you enter, such as start times or watering days, will affect only the selected program.

Back Button

- 1 During programming, press the Back button to go back to the previous screen.

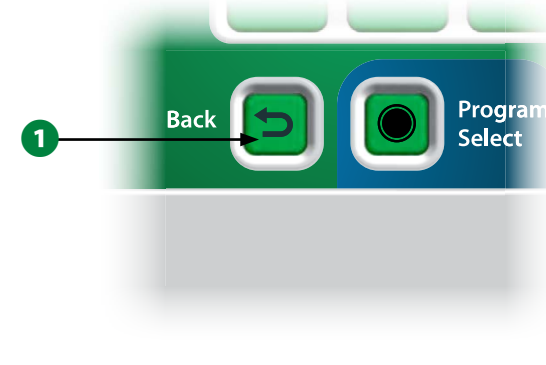

Set Watering Start Times

Start times are the time(s) of day that the program begins.

You can assign up to 8 Start Times to a single program. Multiple Start Times allow you to run a program more than once on each day. For example, if you're growing new lawn seed, you may want to water several times a day to keep the seedbed or top dressing damp.

 **NOTE:** Start times apply to the entire program and not just to an individual station.



Turn the controller dial to Start Times

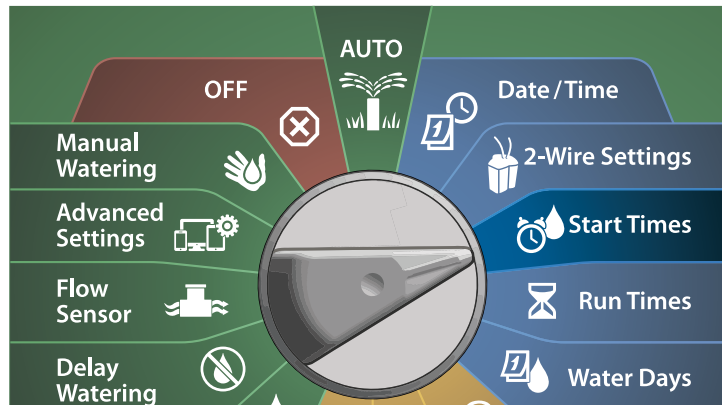

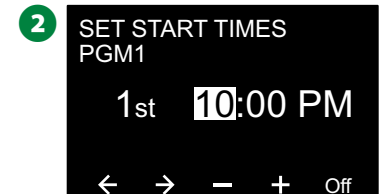
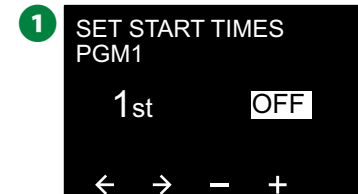

- 1 At the Set Start Times screen, press the + or – key to activate the 1st Start Time.
- 2 Press the + and – keys to set the hour, then press the Right Arrow key. Press the + and – keys to set the minutes.

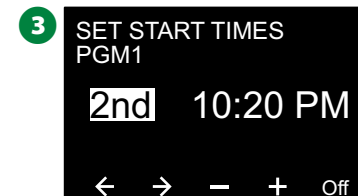

 **NOTE:** If the desired program is not selected, press the Program Select switch to change it. See "Program Select Button" on page 39 for more details.

- 3 Press the Arrow keys to navigate between the number setting fields. Press the + and – keys to set additional Start Times (1 through 8).



 Change the Program Select switch and repeat this process to set up additional Watering Start Times for other programs as desired.

 **NOTE:** Cycle+Soak™ is an alternative method of dividing the total Station Run Time into smaller cycle times. If you plan to use Cycle+Soak, only a single Watering Start Time is required for each program. See "Cycle+Soak™" on page 33 for more details.

Set Station Run Times

Run Times are the number of minutes (or hours and minutes) that each station runs.

Once your stations are set up, you can assign irrigation Run Times for each. Station Run Times are particular to programs, so typically stations are set for a single program.

Turn the controller dial to Run Times

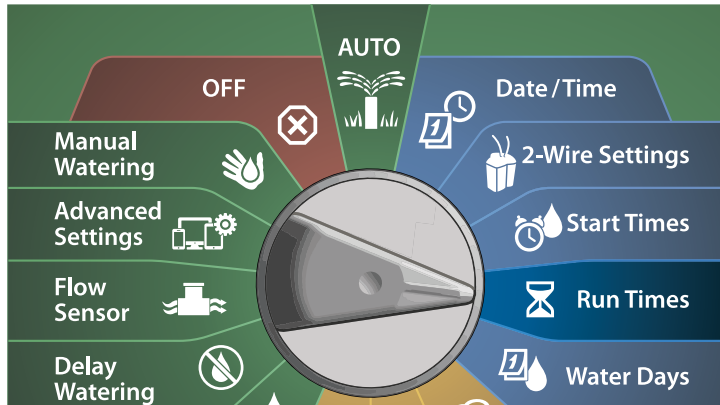

- 1 At the Set Run Times screen, press the first set of + and – keys (1 and 2) to set the station to program.

 NOTE: If the desired program is not selected, press the Program Select button to choose the desired program. See "Program Select Button" on page 39 for more details.

- 2 Press the second set of + and – keys (3 and 4) to set the Station Run Time. Range can be from 00 hours, 00 minutes (no Run Time) up to 96:00 hours.

- Press and HOLD keys to accelerate settings.



-  Change the Program Select switch and repeat this process to set up additional Station Run Times for other programs as desired.

Copy Run Times

You can copy Station Run Times from one program to other programs.

- 1 At the Set Run Times screen, press Copy.
- 2 At the Copy screen, use the <> key to navigate between the number setting fields. Press the + and – keys to set the desired starting and ending station numbers. Press the ✓ key to copy the station data, or press the ✕ key to cancel.

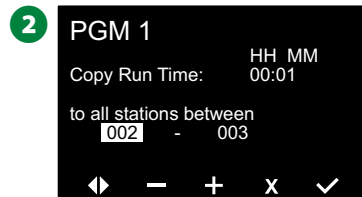

- 3 A confirmation screen shows the process is complete.

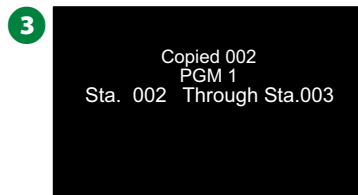

Select Water Days

Watering Days are the specific days of the week on which irrigation is allowed to occur.

The ESP-LXIVM controller supports a variety of flexible watering day cycle options.

- **By Day of Week:** irrigation starts at chosen individual days in the week where program starts are allowed, .
- **Cyclic days:** irrigation starts at regular chosen intervals such as every 3rd or 5th day, regardless of the calendar date.
- **Even Dates:** irrigation starts on all even numbered calendar days, such as the 2nd, 4th, 6th, etc.
- **Odd Dates:** irrigation starts on all odd numbered calendar days, such as the 1st, 3rd, 5th, etc.
- **Odd Dates no 31st:** irrigation starts on all odd numbered calendar days, such as the 1st, 3rd, 5th, etc., but not on the 31st.



NOTE: Regardless of the Watering Cycle, irrigation will start only on days of the week where program starts are allowed.

Custom, By Day of Week

1 Turn the controller dial to Water Days



NOTE: The selections you make on the day positions of the controller dial will carry over to the Watering Cycles day settings and vice versa.

1 The Custom, By Day of Week screen appears.

NOTE: If the desired program is not selected, press the Program Select button to choose the desired program. See "Program Select Button" on page 39 for more details.

2 Press the On key to allow irrigation on a given day of the week or else press Off to prevent irrigation from starting that day. Press the Arrow keys to navigate across the week.



Cyclic Days

1 Turn the controller dial to Water Days



1 At the Watering Cycle screen, press the Mode key to navigate to the Cyclic Days screen.

NOTE: If the desired program is not selected, press the Program Select button to choose the desired program. See "Program Select Button" on page 39 for more details.

2 At the Day Cycle screen, press the + and – key to set the watering day cycle (from 1 to 30 days). For example, set to 03 if you want to water every third day, then press the Down Arrow key.

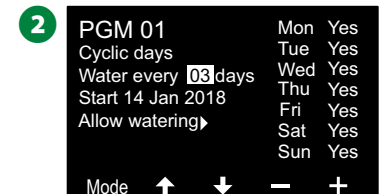

- 3 Press the + and – keys to set the first date for the Watering Cycle to begin, then press the Down Arrow key.
 - Press and HOLD keys to accelerate settings.
- 4 Press the Yes key to allow irrigation to start on a given day of the week or else press No to prevent irrigation from starting that day. Press the Arrow keys to navigate across the week.



Press the Program Select button and repeat this process to select Cyclical Watering for other programs as desired.

NOTE: Watering day selections carry over to Watering Days dial positions and vice-versa. See "Select Water Days" on page 42 for more details.

Custom, Even days, Odd days, Odd no 31st

The process for setting up Custom, Even, Odd, and Odd no 31st Watering Cycles is very similar.

1 Turn the controller dial to Water Days



- 1 At the Watering Cycle screen, press the Mode key to Navigate to the Even days, Odd days or Odd 31st screen.

NOTE: If the desired program is not selected, press the Program Select button to choose the desired program. See "Program Select Button" on page 39 for more details.

- 2 Press the Yes key to allow irrigation to start on a given day of the week or else press No to prevent irrigation from starting that day. Press the Arrow keys to navigate across the week.

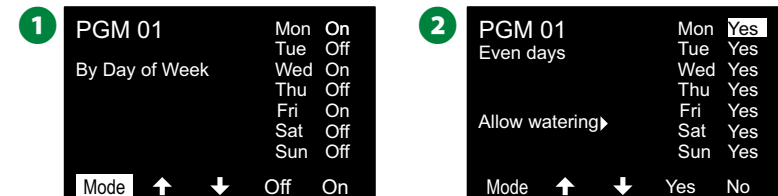

Weather Sensors

The ESP-LXIVM can also accept input from a single weather sensor wired directly to the controller instead of to the 2-Wire path.

Connect Local Weather Sensors

 NOTE: All weather sensors can also be bypassed with the sensor bypass switch on the controller front panel.

- 1 Run continuous sensor wires from the weather sensor to the LX-IVM controller.
- 2 Remove the yellow jumper wire (if present). Connect the sensor wires to the sensor inputs to the right of the 2-Wire path terminals. When finished, tug gently on the wires to make sure the connections are tight.

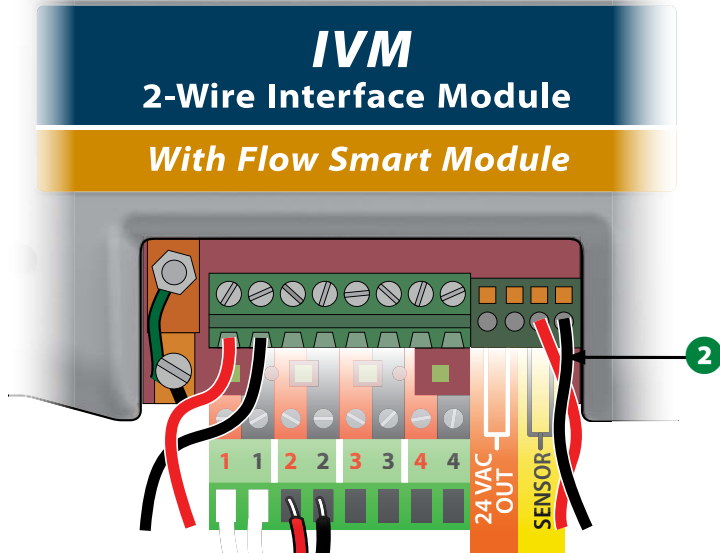

 NOTE: If your weather sensor requires 24V power from the controller, the + and - connectors to the left of the sensor and common connectors can be used.

Turn the controller dial to Weather Sensor



- 1 At the Weather Sensors screen, press the On key to activate the local Weather Sensor or else press Off to bypass. Press the Arrow keys to navigate across the week.



SAFETY INSTRUCTIONS

Follow the sensor manufacturer's instructions to correctly install and make wire connections to the sensor. Ensure the sensor installation is in compliance with all local codes.

Supported Rain Bird® Weather Sensors:

- RSD rain shut off device
- WR2-RC wireless rain sensor
- WR2-RFC wireless rain/freeze sensor

Diagnosics

Test All Stations

You can test all stations connected to the controller by running each of them in station number sequence.

This feature can be useful after installation, for general maintenance or as a first step in troubleshooting your system.

 NOTE: Only stations with programmed run times are included in the Test All Stations operation.

Turn the controller dial to Diagnosics



- 1 At the Diagnosics screen, with Test All Stations selected, press Next.
- 2 At the Test All Stations screen, press the + and – keys to set the desired time (from 1 to 10 minutes), then press Run.

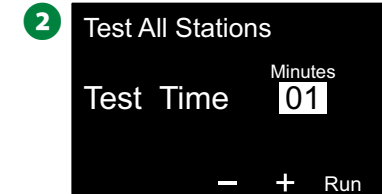
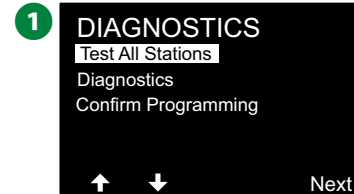

- 3 A confirmation screen shows the test has started.

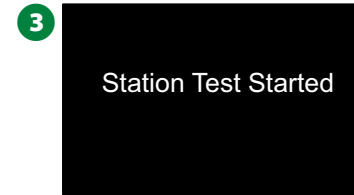

Diagnosics

Run diagnostic tests on the irrigation system

List Not Responding

View List of Field Devices (valves or sensors) that are not responding

 Turn the controller dial to **Diagnosics**



- 1 At the DIAGNOSTICS screen, press the Down Arrow key to select **Diagnosics**, then press Next.
- 2 At the second DIAGNOSTICS screen, with **List Not Responding** selected, press Next.

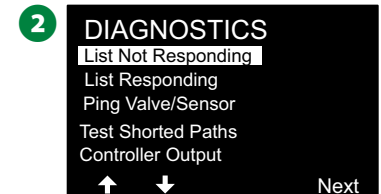
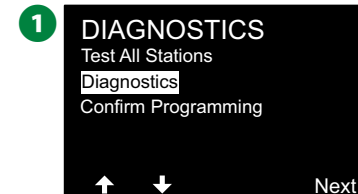

- 3 List of Field Devices (valves or sensors) that are not responding is shown. Press the Arrow keys to navigate the list or press the  key to refresh the list.

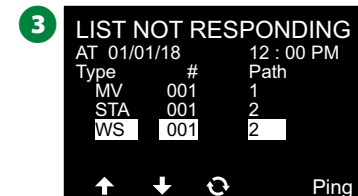

List Responding

View List of View List of Field Devices (valves or sensors) that are responding

Turn the controller dial to Diagnostics



- 1 At the DIAGNOSTICS screen, press the Down Arrow key to select Diagnostics, then press Next.
- 2 At the second DIAGNOSTICS screen, press the Down Arrow key to select List Responding, then press Next.



- 3 List of Field Devices (valves or sensors) that are responding is shown. Press the Arrow keys to navigate the list or press the  key to refresh the list.

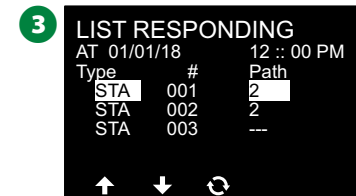

Ping Valve/Sensor

The LX-IVM controller can provide detailed information on a specific 2-Wire Device.

This can be helpful to narrow a repair trip into the field to one 2-Wire Device or a set of 2-Wire Devices on a particular branch of the 2-Wire path. You can ping a Master Valve, Station, Weather Sensor, Flow Sensor Interpretation of the results is essentially the same for Station and MV Devices.



Turn the controller dial to Diagnostics



- 1 At the DIAGNOSTICS screen, press the Down Arrow key to select Diagnostics, then press Next.
- 2 At the second DIAGNOSTICS screen, press the Down Arrow key to select Ping Valve/Sensor, then press Next.

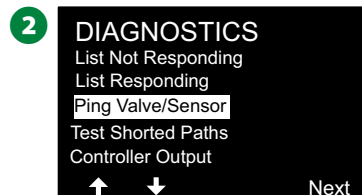
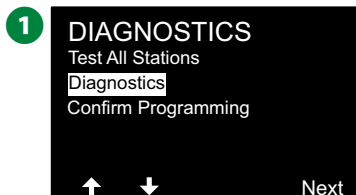

- 3 At the PING VALVE OR SENSOR screen; press the + and – keys to select the type of sensor device that you want to test.
- 4 Press the <> key to select the number setting field. Press the + and – keys to select the number of the sensor device that you want to test, then press Ping.

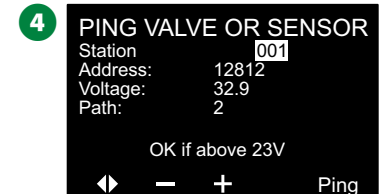
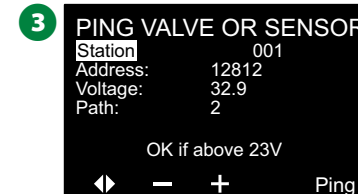

- 5 The controller will ping the selected device and report a voltage reading if the device responded.
- Repeat this process to select another sensor to ping.

Interpreting Ping Results

- If the device does not respond verify the address and check the wire splices.
- The voltage reading is a measurement of the charge of the device capacitors. If the voltage is low, wait a minute then ping again.
- If the voltage is still low (below 23 volts) check the wire splices. If the splices are good replace the device.

Test Shorted Paths

The ESP-LXIVM controller can quickly determine if faults are present on the 2-Wire path.

Although finding the exact location of issues in the field often requires some amount of in-the-field troubleshooting with a clamp meter, the controller has some built-in features to help you narrow down the possible issues.

Before beginning 2-Wire diagnostics, it may be helpful to take the following steps to eliminate possible other causes:

- **Review Station Priorities:** The LX-IVM controller can be configured to irrigate based on the station priorities. If multiple programs are running, higher priority stations will irrigate prior to medium priority stations, and medium priority stations will irrigate prior to lower priority stations. See "Set Priority" on page 29 for more details.
- **Run Test All Stations:** The Test All Stations manual test will take priority above pre-programmed irrigation and allow you to determine which stations are working properly. See "Test All Stations" on page 100 for more details.

Turn the controller dial to Diagnostics



- 1 At the DIAGNOSTICS screen, press the Down Arrow key to select Diagnostics, then press Next.
- 2 At the second DIAGNOSTICS screen, press the Down Arrow key to select Test Shorted Paths, then press Next.

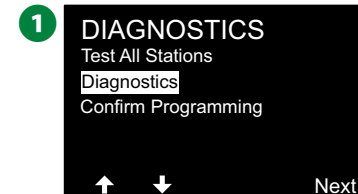

- 3 At the SELECT PATH TO ENERGIZE FOR TESTING screen, press the Down Arrow key to select the desired path for testing, then press Next.
- 4 Press and hold the YES key to energize the current path for testing.

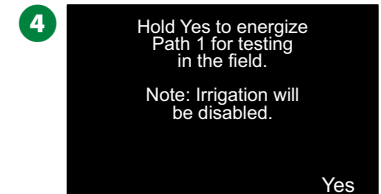
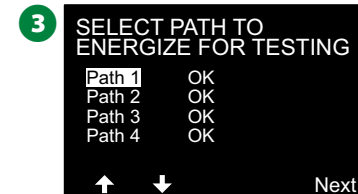

-  Repeat this process to test other PATHS as desired.

Controller Output

If one or more 2-Wire Devices are not working properly, you can run Controller Output diagnostic tests at the controller.

Turn the controller dial to Diagnostics



- 1 At the DIAGNOSTICS screen, press the Down Arrow key to select Diagnostics, then press Next.
- 2 At the second DIAGNOSTICS screen, press the Down Arrow key to select Controller Output, then press Next.

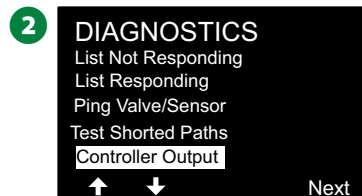
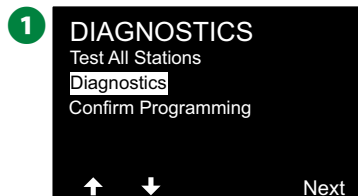

- 3 The Controller Output results will be shown on a single screen.

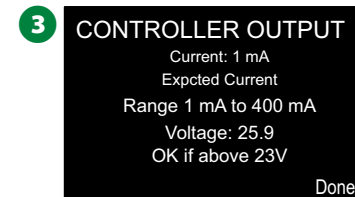

-  NOTE: Current readings show all four 2-Wire paths combined and not a particular path.

Interpreting Controller Output Results

Controller Output checks line voltage and milliamp draw.

Use the range (1 mA to 400mA , Above 23V) to determine if the current are voltage values are outside the limits. If the Controller Output current or voltage values are outside the limits, follow these steps:

1. Remove all 2-Wire path wires from the IVM 2-Wire Interface Module and rerun the Controller Output test. Readings should now be within limits.
2. Reconnect one 2-Wire path wire to the IVM 2-Wire Interface Module at a time. Then rerun the Controller Output test. If the survey results are outside the limits then the 2-Wire path wire that is connected is the source of the problem.
3. Check the 2-Wire path, splices and 2-Wire Device splices for shorted wires or leaks to ground.
4. Press the 2-Wire Diagnostics/Ping 2-Wire Device feature to determine which 2-Wire Devices the LX-IVM controller can communicate with and which devices it cannot communicate with. The 2-Wire splices between the last 2-Wire Device that responds and the first device that does not respond is likely the location of the problem.

Confirm Programming

The ESP-LXIVM controller can make calculations and provide feedback on Start Times and total Run Times for programs and stations.

Program Summary

Review program information for all programs:



Turn the controller dial to Diagnostics



- 1 At the DIAGNOSTICS screen, press the Down Arrow key to select Confirm Programming, then press Next.
- 2 At the CONFIRM PROGRAMS screen, with Program Summary selected, press Next.

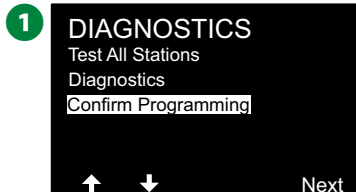

- 3 The Program Summary screen appears, providing a summary of Run Times, Start Times and Water Days for all programs.

PGM	Run Time	Start Time	Water Days
01	Y	Y	Y
02	N	N	N
03	N	N	N

In the example above:

- Program 1 will run because it has Station Run Time, Start Time and Water Days all programmed, as indicated by the “Y” in each column.
- Program 2 and 3 will not run as they are missing all programming, as indicated by the “N” in each column.

Review Programs

Review program information for a station.



Turn the controller dial to Diagnostics



- 1 At the DIAGNOSTICS screen, press the Down Arrow key to select Confirm Programming, then press Next.
- 2 At the CONFIRM PROGRAMS screen, press the Down Arrow key to select Review Programs, then press Next.

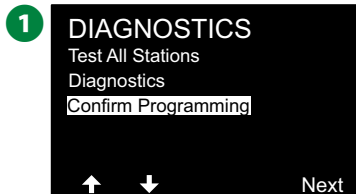

- 3 The Watering Start Times review screen appears with the current watering start times shown. Press Next.

NOTE: If the desired program is not selected, press the Program Select button to choose the desired program. See "Program Select Button" on page 39 for more details.

- 4 The Watering Starts Allowed On review screen appears with allowed watering days shown. Press Next.

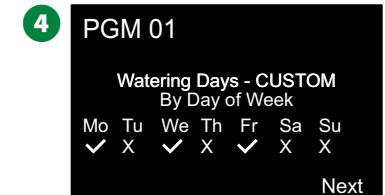
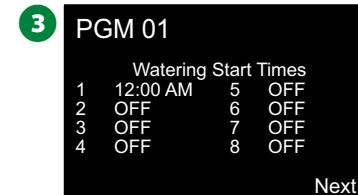

- 5 The Run Times review screen appears with run times for each station shown. Press Next.

- 6 The Seasonal Adjust review screen appears with seasonal adjustment percentage shown. Press Next.



7 The Seasonal Adjust by Month review screen appears with seasonal adjustment percentage shown for the first allowed month. Press the + and – keys to see Seasonal Adjust percentage for other months as desired, then press Next.

8 The Rain Delay review screen appears with number of days remaining until next watering date shown. Press Next.



9 The Calendar Day Off review screen appears with all selected calendar days off shown. Press Next.

10 The Station Delay review screen appears with time delay between stations shown. Press Next.

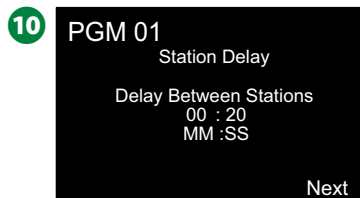

11 The Cycle+Soak Minutes review screen appears with the Cycle+Soak times for each station shown. Press Next.

12 The Master Valve Assignment review screen appears with MV and associated FloZone information shown. Press Next.

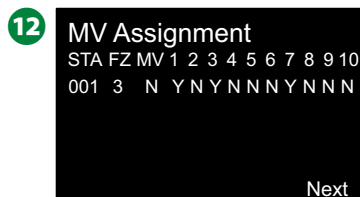

13 The Weather Sensor Assignment review screen appears with stations that use sensor override shown. Press Next.

14 The Water Window review screen appears with water window open time, close time and duration shown. Press Next.

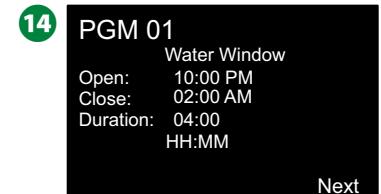
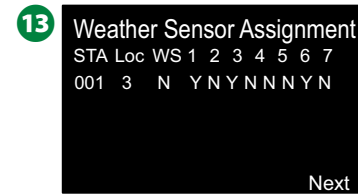

15 The Maximum Number of SimulStations for program review screen appears with the maximum number of stations that can operate simultaneously for that program are shown. Press Next.

16 The Maximum Number of SimulStations for controller review screen appears with the maximum number of stations that can operate simultaneously for that controller are shown. Press Next.

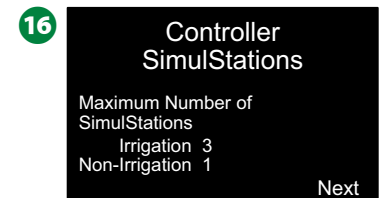
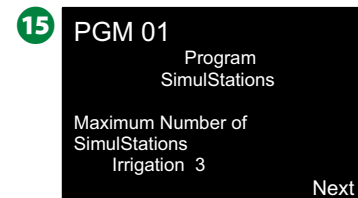

17 A confirmation screen shows the process is complete.

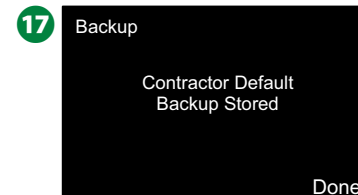

Program Run Times

Review total Run Time for an individual program.

Turn the controller dial to Diagnostics



- 1 At the DIAGNOSTICS screen, press the Down Arrow key to select Confirm Programming, then press Next.
- 2 At the CONFIRM PROGRAMS screen, press the Down Arrow key to select Program Run Times, then press Next.

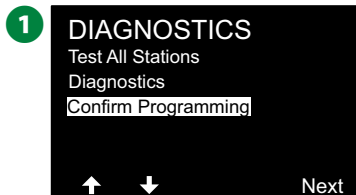

- 3 The Total Run Time screen appears and total Run Time is shown for the currently selected program.

 NOTE: If the desired program is not selected, press the Program Select button to choose the desired program. See "Program Select Button" on page 39 for more details.



 NOTE: For stations set up for Cycle+Soak, the Cycle Time (when irrigation is occurring) will be included in Program Run Time calculations but Soak times will NOT be included. See "Cycle+Soak™" on page 33 for more details.

 Change the Program Select switch and repeat this process to review and confirm Program Run Times for other programs as desired.

Station Run Times

Review total Run Time for all stations.

Turn the controller dial to Diagnostics



- 1 At the DIAGNOSTICS screen, press the Down Arrow key to select Confirm Programming, then press Next.
- 2 At the CONFIRM PROGRAMS screen, press the Down Arrow key to select Station Run Times, then press Next.

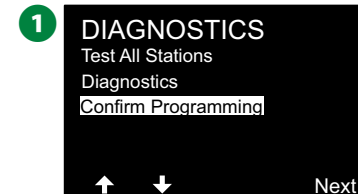

- 3 At the Station Run Time screen, press the + and – keys to select the desired Station. Station Run Times are shown for the currently selected station in all programs.
- 4 Press the Arrow keys to scroll the list of programs. For Stations where a particular Program is not used then no run time is shown.

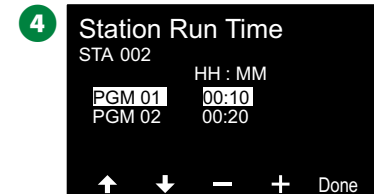

-  NOTE: Soak times for stations set up with Cycle+Soak are not included in the Station Run Time calculations. See "Cycle+Soak™" on page 33 for more details.

Review Master Valves

Review status of Master Valves.

Turn the controller dial to Diagnostics



- 1 At the DIAGNOSTICS screen, press the Down Arrow key to select Confirm Programming, then press Next.
- 2 At the CONFIRM PROGRAMS screen, press the Down Arrow key to select Review Master Valves, then press Next.

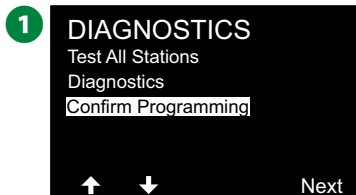

- 3 The Master Valves screen appears, showing installed master valves, their type (Normally Closed or Normally Open), their current status (open or closed) and if they are included in the MV Water Window (Yes or No).

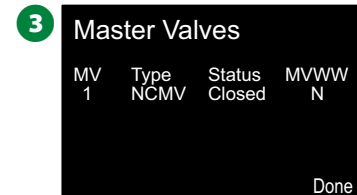

Review Weather Sensors

Review status of Weather Sensors.

Turn the controller dial to Diagnostics



- 1 At the DIAGNOSTICS screen, press the Down Arrow key to select Confirm Programming, then press Next.
- 2 At the CONFIRM PROGRAMS screen, press the Down Arrow key to select Review Weather Sensors, then press Next.

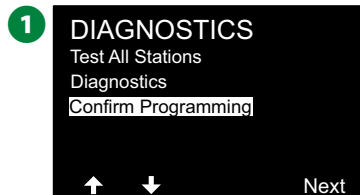

- 3 The Weather Sensor Status screen appears, showing installed weather sensors and their current status as either On or Off. Press the Arrow keys to scroll the list.

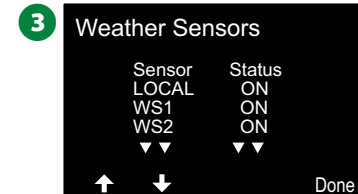

Alarms/History

Flow History

With FloWatch™ enabled, the controller will automatically track the volume of water flowing through the system.

 NOTE: This can be useful for checking your actual water consumption against your water bill.

 Turn the controller dial to Alarms/History



1 At the ALARMS AND HISTORY screen, with Flow History selected, press Next.

2 The Flow History screen appears, showing month-to-date and last month water consumption.

 NOTE: Press the Days key to change the view to the last 30 days and previous 30 days.

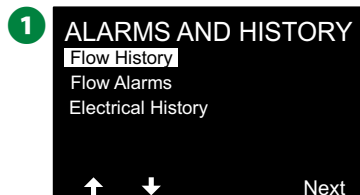

3 At the Clear Flow History confirmation screen, press the Yes key to continue. If you're not sure, press the No key.

4 The confirmation screen appears, showing that Flow History has been cleared.

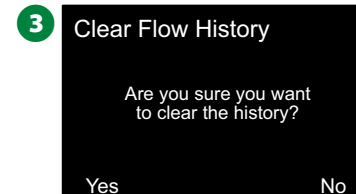

 NOTE: Pressing Clear from either the monthly or daily screen will clear BOTH monthly and daily flow log data.

Flow Alarms

The LX-IVM controller can be set up to issue alarms when flow conditions are in excess of your High Flow settings or below your Low Flow settings.

Occasionally a flow condition will be detected. If the controller is set up to issue alarms for these conditions, the alarm light will illuminate and detailed descriptions of the Flow Alarm conditions will be created.

Station Flow Alarms

 Turn the controller dial to Alarms/History



- 1 At the ALARMS AND HISTORY screen, press the Down Arrow key to select Flow Alarms, then press Next.
- 2 At the Flow Alarms screen, with Station Flow Alarms selected, press Next.

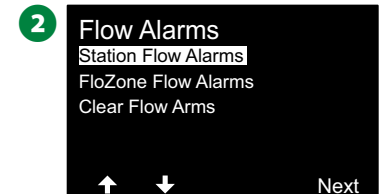

- 3 The Station Flow Alarms screen appears, showing the first station where there is an alarm. Press the + and - keys to view the next Station Flow Alarm.

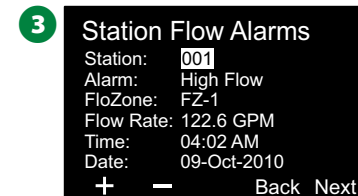

Note each station which has an alarm, then see "Clear Flow Alarms" on page 63 for more details on how to clear flow alarms.

FloZone Flow Alarms

 Turn the controller dial to Alarms/History



- 1 At the ALARMS AND HISTORY screen, press the Down Arrow key to select Flow Alarms, then press Next.
- 2 At the Flow Alarms screen, press the Down Arrow key to select FloZone Flow Alarms, then press Next.

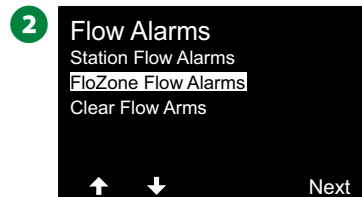
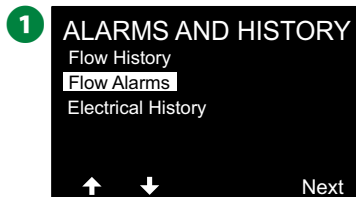

- 3 At the FloZone Alarms screen, press the + and – keys to view other FloZone flow alarms.



Note each station which has an alarm, then see "Clear Flow Alarms" on page 63 for more details on how to clear flow alarms.

Clear Flow Alarms

 Turn the controller dial to Alarms/History



- 1 At the ALARMS AND HISTORY screen, press the Down Arrow key to select Flow Alarms, then press Next.
- 2 At the Flow Alarms screen, press the Down Arrow key to select Clear Flow Alarms, then press Next.

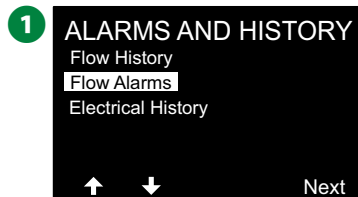

- 3 The Clear All Flow Alarms screen appears. Press Yes to clear all Station and FloZone Flow Alarms.
- 4 A confirmation screen shows that Flow Alarms have been cleared.

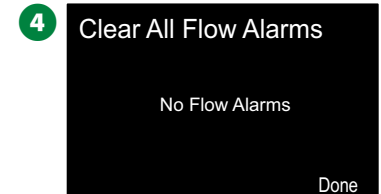
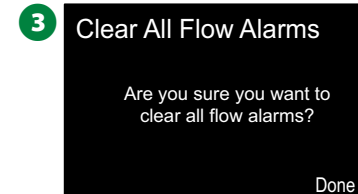

Electrical History

View the Electrical History for the last 30 days or for the last 12 months.

Stations, Master Valves and Sensors

 Turn the controller dial to Alarms/History



- 1 At the ALARMS AND HISTORY screen, press the Down Arrow key to select Electrical History, then press Next.

30 Days Electrical History

- 2 At the ELECTRICAL HISTORY screen, with STA, MV & SENSORS > 30 days selected, press Next.

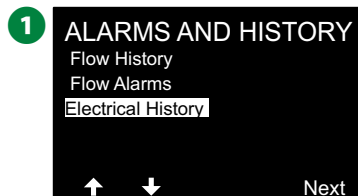

- 3 At the VOLTAGE - 30 DAYS screen, press the + / - keys to select the device type, then press < > to select the device number field and use + / - to select the device number to view history for.
- 4 Press the Up or Down arrow keys to navigate and view three consecutive dates during a month for which you would like to see the 30 days electrical history.

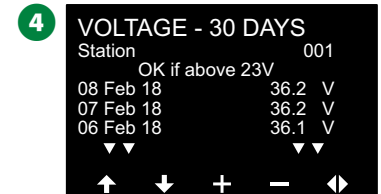
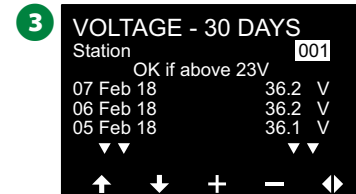

 NOTE: Current readings show all four 2-Wire paths combined and not a particular path.

12 Months Electrical History

- 1 At the ELECTRICAL HISTORY screen, press the Down Arrow key to select STA, MV & SENSORS > 12 months, then press Next.
- 2 At the VOLTAGE - 12 MONTHS screen, press the DOUBLE-ARROW key to select the desired Station field. Then press the + and - keys to select the desired Station number to view history for.



- 3 Press the Down arrow key to navigate and view three consecutive months for which you would like to see the 12 months electrical history.

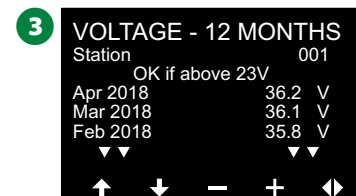

Controller Output

View the Controller Output for the last 30 days or for the last 12 months.

 Turn the controller dial to Alarms/History



1 At the ALARMS AND HISTORY screen, press the Down Arrow key to select Electrical History, then press Next.

30 Days Electrical History

2 At the ELECTRICAL HISTORY screen, press the Down Arrow key to select Controller Output > 30 days, then press Next.

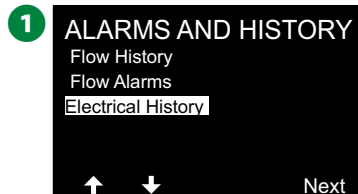

3 Press the Up or Down arrow keys to navigate and view three consecutive dates during a month for which you would like to see the controller output history.

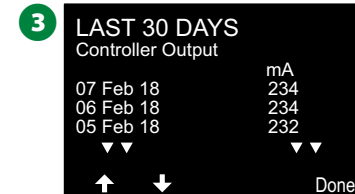

12 Months Electrical History

1 At the ELECTRICAL HISTORY screen, press the Down Arrow key to select Controller Output > 12 months, then press Next.

2 Press the Down arrow key to navigate and view three consecutive dates during a month for which you would like to see the controller output history.



Seasonal Adjust

Seasonal Adjust allows you to use the heaviest irrigation season as a baseline so that lesser amounts of watering occur during those seasons.

For example, you could set July at 100% and set October to 50% so there would be half as much watering in Fall than in Summer. Seasonal adjustments can be managed by month or by program.

NOTICE

Multiple Seasonal Adjustment settings affect each other and can significantly impact irrigation. For example, if you set a program-level Seasonal Adjustment of 10% and then a monthly Seasonal Adjustment of 10% then irrigation will be reduced to 1% of normal (10% of 10%). Consider using only one type of Seasonal Adjustment setting.

Setting a small number for the Seasonal Adjustment percentage will greatly reduce watering and setting to 0% will cancel irrigation entirely. Use caution when making Seasonal Adjustment settings.

Individual Program

Seasonal Adjust can be set to adjust by individual program.



Turn the controller dial to Seasonal Adjust



- 1 At the SEASONAL ADJUST screen, with Individual Program selected, press Next.
- 2 Press the + and – keys to set the seasonal adjustment percentage (from 0 - 300%).
 - Press and HOLD keys to accelerate settings.



NOTE: If the desired program is not selected, press the Program Select button to choose the desired program. See "Program Select Button" on page 39 for more details.

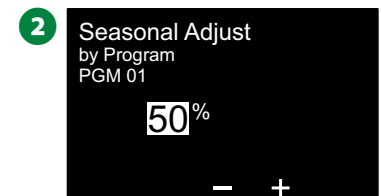

By Month

% Adjust

Seasonal Adjust can be set to adjust by the specific month.

Turn the controller dial to Seasonal Adjust



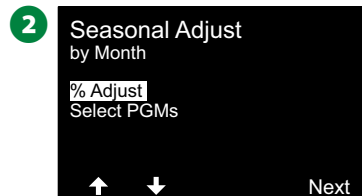
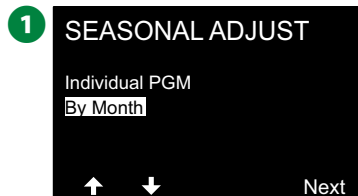

- 1 At the SEASONAL ADJUST screen, press the Down Arrow key to select By Month, then press Next.
- 2 At the Seasonal Adjust by Month screen, with % Adjust selected, press Next.



- 3 Press the + and - keys to select the month you would like to adjust.
- 4 Press the Right Arrow key to select the percentage field. Then press the + and - keys to set the percentage (from 0 - 300%).
 - Press and HOLD keys to accelerate settings.



-  Repeat this process to set Seasonal Adjustments for other months as desired. Then change the Program Select switch and repeat this process to set Seasonal Adjustments By Month for other programs as desired.

 NOTE: The % Adjust will automatically change to the new month's percentage setting on the first day of the month.

Select Programs

Seasonal Adjust can be set to adjust by program for specific months.



Turn the controller dial to Seasonal Adjust



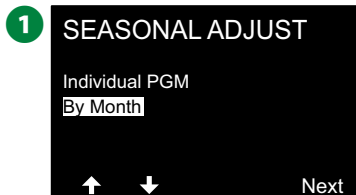

- 1 At the SEASONAL ADJUST screen, press the Down Arrow key to select By Month, then press Next.
- 2 At the Seasonal Adjust by Month screen, press the Down Arrow key to choose Select PGMs, then press Next.

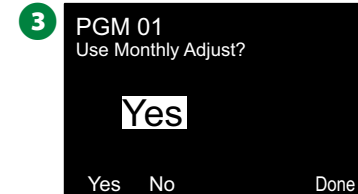

- 3 Press the Yes or No keys to set Monthly Adjust for the current selected program.

 NOTE: If the desired program is not selected, press the Program Select button to choose the desired program. See "Program Select Button" on page 39 for more details.



- 3  Repeat this process to set Monthly Adjustments for other programs as desired.

Delay Watering

Rain Delay

The ESP-LXIVM controller's Rain Delay feature lets you discontinue irrigation for a few days after a period of heavy rain.

 NOTE: If you have a rain sensor attached to the controller, it may be unnecessary to manually program a Rain Delay. Consult the rain sensor device documentation for more details.

Turn the controller dial to Delay Watering



- 1 At the Delay Watering screen, with Rain Delay selected, press Next.
- 2 At the Rain Delay screen, press the Arrow key to choose the starting date (from) and the end date (to) for the Rain Delay. Press the + and - keys to set the number of days (from 0 to 30 days). Press the Clear key if you want to cancel the Rain Delay.

 NOTE: The next irrigation date after the Rain Delay calculates and shows automatically.



 NOTE: A Rain Delay affects all programs, but stations set up as Non-irrigation will still run during a Rain Delay.

Calendar Day Off

The LX-IVM controller can be programmed to suspend irrigation on a particular calendar date, for up to 5 days of the year.

You can schedule certain days of the year as Non-irrigation, such as holidays when landscape may receive heavy use.

 NOTE: Calendar Day Off dates can only be selected 365 days in advance. Then once a Calendar Day Off has passed, it will be removed from the list and must be reprogrammed for the following year if desired.

Turn the controller dial to Delay Watering



- 1 At the Delay Watering screen, press the Down Arrow key to select Calendar Day Off, then press Next.
- 2 The Calendar Day off screen appears, showing (up to 5) scheduled calendar days off in chronological order. Unprogrammed days will show as Unused.

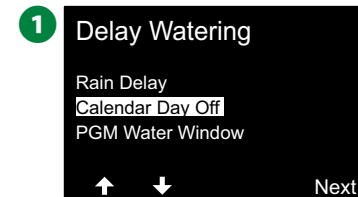

- 3 Press the + and – keys to set the Calendar Day Off date as desired. Press the Next and Back buttons to set other days as desired.
 - Press and HOLD keys to accelerate settings.



 NOTE: Calendar Day Off affects ALL programs and stations, including non-irrigation stations. Consider not using this feature if any of your programs include essential functions such as door locks or sports field lighting.

Program Water Window

You can specify certain times of the day/night when irrigation is allowed.

Watering is not allowed outside these "Water Windows". This is helpful to comply with local regulations which may prohibit irrigation during certain hours.

NOTICE

Be sure a Water Window is sufficient to allow irrigation programs to run completely. Irrigation scheduled outside the Water Window will be paused and will resume when the Water Window opens again. This can cause irrigation programs to "stack" and eventually create an alarm condition if the controller stacks 8 or more programs.

 NOTE: Water windows can be scheduled to cross midnight. For example, a Water Window can start at 10:00 PM and continue until 4:00 AM the next morning. Be sure your Watering Start Times are set to occur within the Water Window. See "Set Watering Start Times" on page 40 for more details.

Water Window Set Up

 Turn the controller dial to Delay Watering



- 1 At the Delay Watering screen, press the Down Arrow key to select PGM Water Window, then press Next.
- 2 At the Water Window screen, press the + and – keys to set the time when the Watering Window opens, then press the Down Arrow key.
 - Press and HOLD keys to accelerate settings.



- 3 Press the + and – keys to set the time when the Watering Window closes. As you adjust the close time, the duration of your Water Window calculates automatically.

 NOTE: To clear a previously set Water Window, press the + and – keys to set both the Open and Close times to OFF (between 11:59 and 12:00 AM).

- 4 Use the Program Select switch to set the Water Window for another program, if desired.

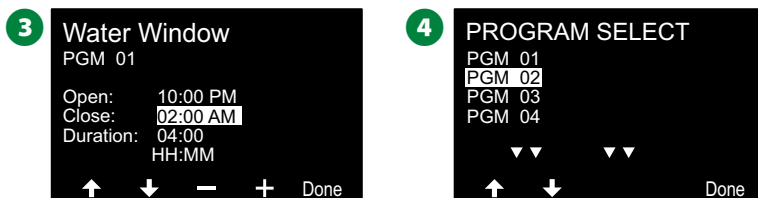

Flow Sensor

Introduction to Flow

The ESP-LXIVM controller offers a wide variety of flow-related functionality to utilize your system more efficiently, with or without additional flow sensing hardware.

FloZones Overview

A FloZone is a collection of one or more stations all using the same water source.

In a simple irrigation system such as a private residence, water is often supplied from a single source (typically from the local municipality) and in that case all stations are part of a single FloZone.

In a typical commercial installation, each FloZone will have its water source(s) controlled by individual Master Valve(s) (or MVs). For this reason, the number of FloZones is often the same as the number of MVs.

 NOTE: The number of FloZones can never be greater than the number of water sources and if multiple water sources (and likely MVs) supply the same section, then the number of FloZones will be less than the number of MVs.

- The LX-IVM supports up to 5 Master Valves, so as many as 5 FloZones can be created. The LX-IVM Pro supports up to 10 Master Valves, so as many as 10 FloZones can be created.

An irrigation system consisting of 5 MVs flowing into 5 individual main lines would result in 5 FloZones. An irrigation system consisting of 10 Master Valves flowing into one shared main line would result in 1 FloZone.

It's important to fully understand your system's hydraulic properties to set up your water sources, MVs and FloZones appropriately. For more information on setting up MVs and FloZones, see "Master Valves" on page 24 for more details.

Pumps are assigned to a single Master Valve and are activated only when that MV is in use. Additionally, pumps can be configured to activate at the station level, but only for stations assigned to the same Master Valve as the pump, see "Assign Pumps by Station (Optional)" on page 30 for more details.

Flow Management Features

After setting the Master Valves and FloZones for your system, the next step is to decide which flow-related features you'd like to use.

The LX-IVM controller flow features can be divided into two different functional groups; Flo-Manager® and FloWatch.

Flo-Manager®

Flo-Manager® adds basic hydraulic management features to your system to ensure that sufficient water pressure and volume is available to operate all stations.

 NOTE: Although it is helpful, flow sensing hardware is not required to use Flo-Manager®. You can manually enter estimated flow rates even if flow sensing hardware is not installed.

FloWatch™

FloWatch allows you to use any or all of the Flo-Manager® features but adds additional functionality such as alarms for high flow and low flow situations based on parameters you set and control. See "Set Flow Limits" on page 84 for more details.

 NOTE: Flow sensing hardware is required to use FloWatch.

Set Flow Rates

The LX-IVM controller lets you set the flow rates you expect or to automatically Learn Flow rates based on real usage.

If you do not have flow sensing hardware installed you may be able to estimate flow rates based on the irrigation hardware installed on a particular station or FloZone and manually enter this rate.

FloZone flow rates are either:

- Automatically set to the highest station flow rate assigned to the FloZone, or
- Manually adjusted by the user.

Learn Flow Automatically

 NOTE: To ensure accurate recording of flow rates, do not create any manually-generated flow such as flow created with manually operated quick coupling valves, while a Learn Flow is taking place.

All Stations

 NOTE: Ensure you have Run Times set up for all stations included in a Learn Flow exercise prior to setting up a Learn Flow.

 **Turn the controller dial to Flow Sensor**



- 1 At the FLOW SENSOR screen, with Set Flow Rates selected, press Next.
- 2 At the Set Flow Rates screen, with Learn Flow selected, press Next.

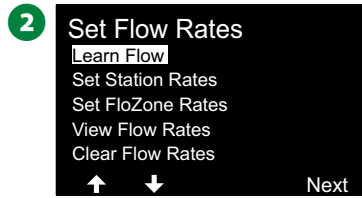
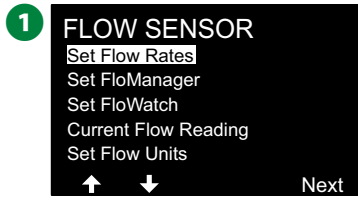

3 At the LEARN FLOW MENU screen, with All Stations selected, press Next.

4 A confirmation screen appears; press Next again.

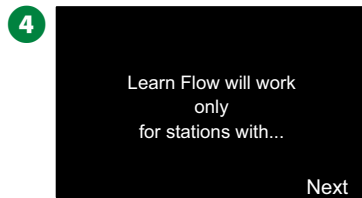

5 An information screen appears; press Next again.

6 To start the Learn Flow exercise immediately, press Next. Or else press the + and – keys to set a delayed start time. Press the Arrow keys to navigate between the number setting fields.

NOTE: You can choose to run the exercise Now (00:00) or choose a timed delay of up to 24 hours.

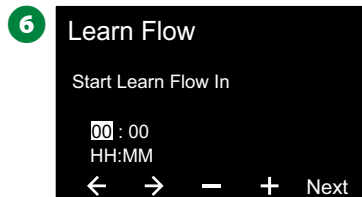
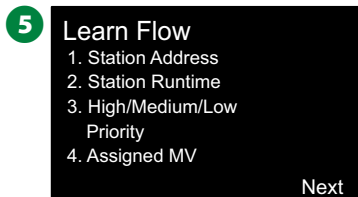

7 A confirmation screen appears, confirming the Learn Flow will overwrite the existing flow rates. Press Start to set the Learn Flow exercise.

8 The Learn Flow Starting confirmation screen shows the time delay until the Learn Flow operation will start.

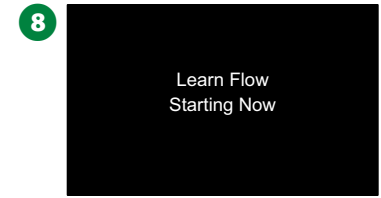
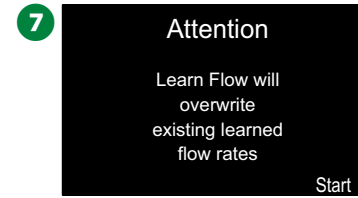

NOTE: An alarm will be posted if one or more stations learn a flow rate of 0 (zero). Check the valve and 2-Wire Device if you receive this alarm.

NOTICE
Be sure to Learn Flow again if you make any changes to your system which affect its hydraulics.

Selected Stations

NOTE: Ensure you have Run Times set up for all stations included in a Learn Flow exercise prior to setting up a Learn Flow.

Turn the controller dial to Flow Sensor



1 At the FLOW SENSOR screen, with Set Flow Rates selected, press Next.

2 At the Set Flow Rates screen, with Learn Flow selected, press Next

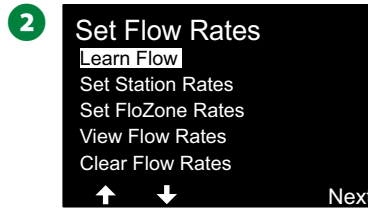
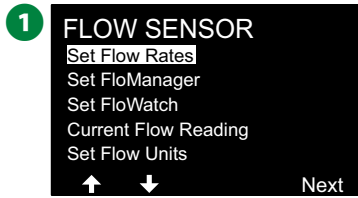

3 At the LEARN FLOW MENU screen, press the Down Arrow key to select Select Stations, then press Next.

4 A confirmation screen appears; press Next again.

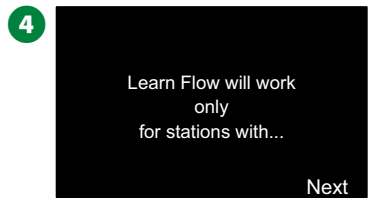

5 An information screen appears; press Next again.

6 Press the Arrow keys to navigate the list of stations. Press the Yes and no keys to set which stations you want to include in the Learn Flow exercise, then press Next to continue.

 NOTE: You can choose to run the exercise Now (00:00) or choose a timed delay of up to 24 hours.

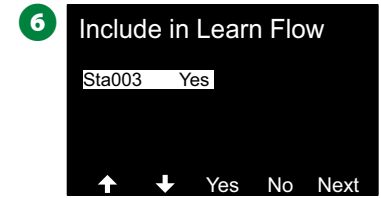
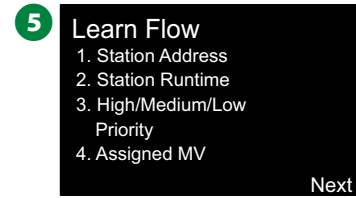

7 To start the Learn Flow exercise immediately, press Next. Or press the + and – keys to set a delayed start time. Press the Arrow keys to navigate between the number setting fields.

8 A confirmation screen appears, confirming the Learn Flow will overwrite the existing flow rates. Press Start to set the Learn Flow exercise.

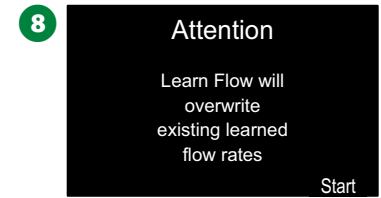
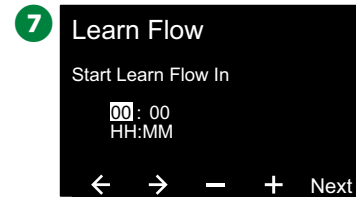

9 The Learn Flow Starting confirmation screen appears, confirming the time delay until the Learn Flow operation will start.



 NOTE: An alarm will be posted if one or more stations learn a flow rate of 0 (zero). Check the valve and 2-Wire Device if you receive this alarm.

NOTICE

Be sure to Learn Flow again if you make any changes to your system which affect its hydraulics.

Set Station Rates

 Turn the controller dial to Flow Sensor



1 At the FLOW SENSOR screen, with Set Flow Rates selected, press Next.

2 At the Set Flow Rates screen, press the Down Arrow key to select Set Station Rates, then press Next.

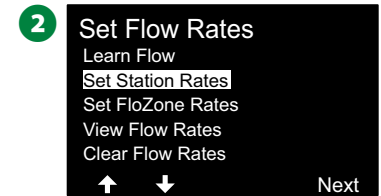
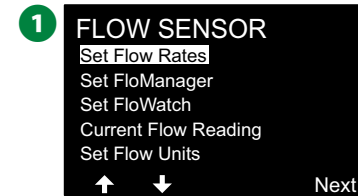

3 At the Set Station Rates screen, press the + and – keys to set the desired Station (from 1 to 240), then press the Right Arrow key.

4 Press the + and – keys to set the desired Flow Rate for that station. Press the Arrow keys to navigate between the number setting fields.

- Press and HOLD keys to accelerate settings.

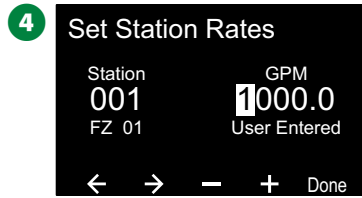
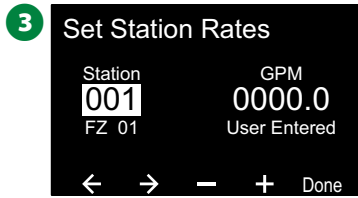

Repeat this process to manually set up Flow Rates for additional stations as desired.

Set FloZone Rates

 Turn the controller dial to Flow Sensor



- At the FLOW SENSOR screen, with Set Flow Rates selected, press Next.
- At the Set Flow Rates screen, press the Down Arrow key to select Set FloZone Rates, then press Next.

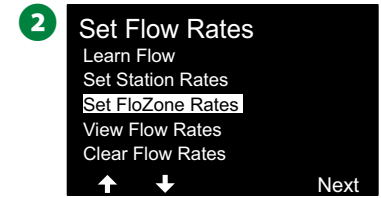
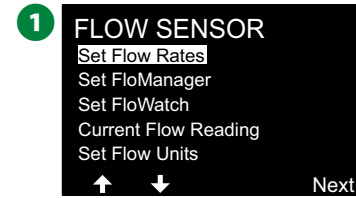

- The Set FloZone Rates information screen appears; press Next.
- At the Set FloZone Rates screen, press the + and – keys to choose the desired FloZone (from 1-10).

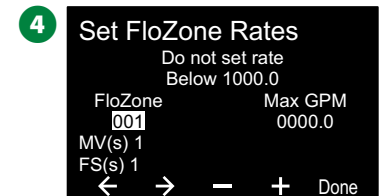
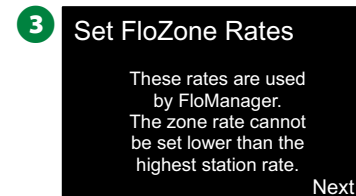

- Press the + and – keys to set the Max GPM for that FloZone. Press the Arrow keys to navigate between the number setting fields.
 - Press and HOLD keys to accelerate settings.

NOTICE
Maximum FloZone flow rates are used only by Flo-Manager®. FloWatch is unaffected by user-entered FloZone flow rates.

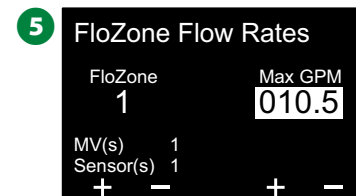

Repeat this process to manually set up Flow Rates for additional FloZones as desired.

After Flo-Manager® is enabled and station and/or FloZone flow rates are entered, Flo-Manager® works automatically in the background to run stations based on available hydraulic capacity

 **NOTE:** Flo-Manager® can be used with or without flow sensing hardware. If flow sensors are not present it will rely on manually entered information; if flow sensors are present it will rely on Learned Flow information, which is typically more accurate.

View Flow Rates

Occasionally you may want to view flow rates and their source for a station or flow zone.

View Station Rates

 **Turn the controller dial to Flow Sensor**



1 At the FLOW SENSOR screen, with Set Flow Rates selected, press Next.

2 At the Set Flow Rates screen, press the Down Arrow key to select View Flow Rates, then press Next.

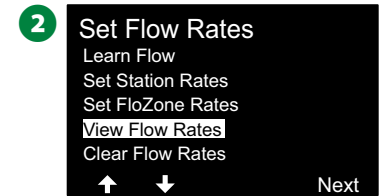
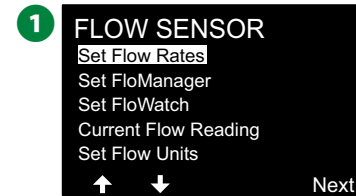

3 The View Flow Rates screen appears with View Station Rates selected; press Next.

4 At the View Station Rates screen, press the + and – keys to set the desired station number. The flow zone for each station is shown below it. The normal flow rate for each station will show to the right, and the source of the flow rate (Learned or User Entered) shows below it.

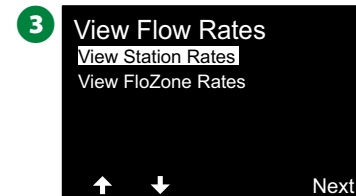

View FloZone Rates

Turn the controller dial to Flow Sensor



- 1 At the FLOW SENSOR screen, with Set Flow Rates selected, press Next.
- 2 At the Set Flow Rates screen, press the Down Arrow key to select View Flow Rates, then press Next.

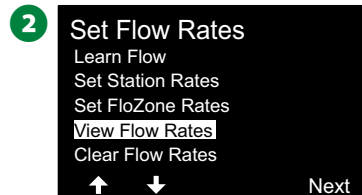
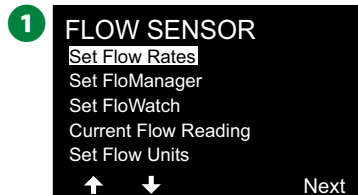

- 3 At the View Flow Rates screen, press the Down Arrow key to select View FloZone Rates, then press Next.
- 4 At the FloZone Flow Rates screen, press the + and – keys to select the desired FloZone number. The MVs and sensors associated with that flow zone are shown below it. The maximum flow rate for that FloZone will show to the right.

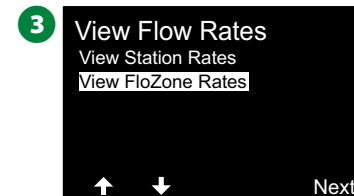

Clear Flow Rates

Occasionally it may be desired to clear the previously learned or user entered flow rates and start all over again.

 Turn the controller dial to Flow Sensor



- 1 At the FLOW SENSOR screen, with Set Flow Rates selected, press Next.
- 2 At the Set Flow Rates screen, press the Down Arrow key to select Clear Flow Rates, then press Next.

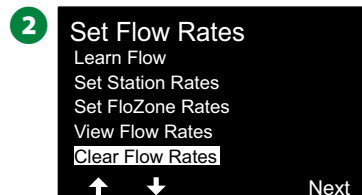
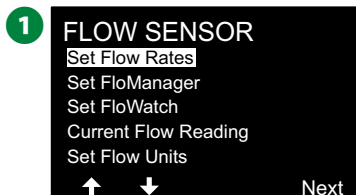

- 3 The confirmation screen appears; press Next to clear flow rates.
- 4 A confirmation screen shows the process is complete.

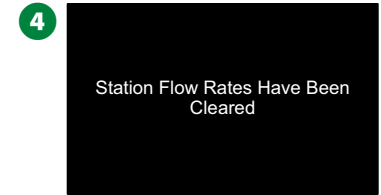
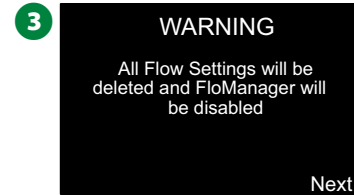

Set Flo-Manager®

One of the most powerful flow management features in the ESP-LXIVM controller is Flo-Manager®.

Flo-Manager® enables the controller to allocate available water capacity to various stations based on their hydraulic requirements. This can be done even if flow sensors are not present.

Flo-Manager® works by adding another layer of station or FloZone prioritization based on available water resources. For example, if FloZone 1 has 20 GPM available flow and two stations each consuming 6 GPM are currently in operation for a total of 12 GPM, Flo-Manager® Will not allow an additional station to start unless it consumes 8 GPM or less. This helps ensure that your system's hydraulic resources are not overtaxed and that sufficient water is available to every sprinkler in every station.

Flo-Manager® Set Up

 NOTE: If you have not already done so, use the 2-Wire Settings dial position to set up all master valves and their FloZones. See "Master Valves" on page 24 for more details.

It's not necessary to install or set up flow sensors to use Flo-Manager®, but if you do have this hardware present it's usually helpful to set it up prior to activating Flo-Manager®. See "Flow Sensors" on page 31 for more details.

Once Flo-Manager® has been activated we recommend that you Learn Flow or manually enter flow rates for all stations and FloZones. This will allow Flo-Manager® to dynamically allocate water resources. If you do not have flow sensing hardware installed you may be able to estimate flow rates based on the irrigation hardware installed on a particular station or FloZone and manually enter this rate.

Enable or Disable Flo-Manager®

Turn the controller dial to Flow Sensor



- 1 At the FLOW SENSOR screen, press the Down Arrow key to select Set Flo-Manager®, then press Next.
- 2 At the Flo-Manager® screen, press the On key to turn on Flo-Manager®.

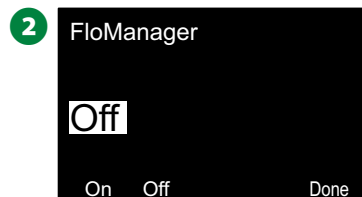
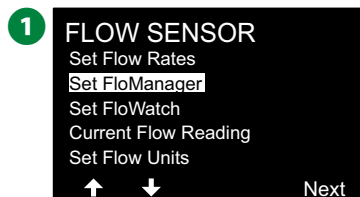

- 3 The confirmation screen appears. Press Accept to turn on FloManager.

 NOTE: Turning on Flo-Manager® changes Station Sequencing to Station Priorities. If you're not sure about it press the Reject key.

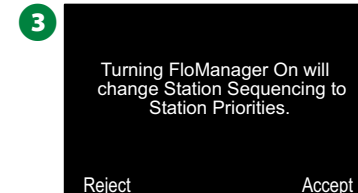

Set FloWatch™

FloWatch unleashes the true power of the ESP-LXIVM controller.

FloWatch compares current flow conditions to expected, learned or user-entered flow rates and takes various actions based on your settings and input. Since current flow conditions are required, FloWatch can only be used when flow sensors are present. To use FloWatch, you must do all of the following:

1. Install flow monitoring hardware into the appropriate locations of your irrigation system. You should install one flow sensor just downstream of each master valve but upstream of any station valves. To ensure stable readings, flow sensors should be installed at least ten times the distance of the pipe diameter downstream of the Master Valve with an additional five pipe diameter distance between the flow sensor and any additional hardware.
2. Connect each flow meter to an LX-IVM-Sensor Device. For more details, see the ESP-LXIVM Field Device Installation Guide that came with the controller.
3. Set up the flow sensors using the flow sensor setup. See "Flow Sensors" on page 31 for more details.

- Follow the directions below to set up FloWatch.

 NOTE: Once you have set up FloWatch on the controller, the current flow rate will be shown on the Auto screen unless you turn off FloWatch. For more information on turning FloWatch on and off, see "Setting Up and Using flow" below.

FloWatch™ Set Up

The ESP-LXIVM controller lets you set the flow rates you expect or to automatically Learn Flow rates based on real usage.

Once flow is learned or manually entered, the High Flow and Low Flow settings let you define the parameters for excessive or low flow and to set the behavior of the controller when these conditions are detected. You can also turn FloWatch off or back on again if you like.

FloWatch needs expected flow rates to work properly. Flow rates can be entered manually or can be learned automatically through a Learn Flow process. An automatic Learn Flow operation will Learn Flow for each station that has programmed Run Times. Ensure you have set up runtimes for all stations included in a Learn Flow exercise prior to setting up a Learn Flow.

 NOTE: Prior to learning or manually setting station flow rates, it is a good idea to check the Master Valve assignments for each of your stations. See "Station Setup" on page 28 for more details.

NOTICE

Water pressure, particularly from municipal sources, can vary significantly throughout the day. To mitigate this variance, press the time delay option to delay the Learn Flow start time to when irrigation would normally operate.

FloWatch™ On/Off

 Turn the controller dial to Flow Sensor



- At the FLOW SENSOR screen, press the Down Arrow key to select Set FloWatch, then press Next.
- At the FloWatch screen, with FloWatch selected, press On/Off, then press Next.

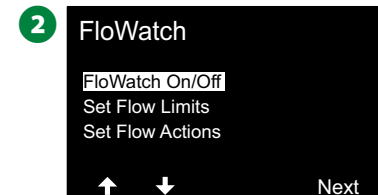
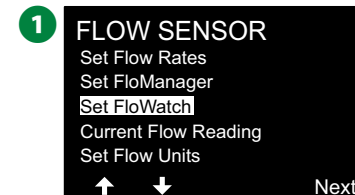

- Press the On key to turn on FloWatch, or else press Off to disable.

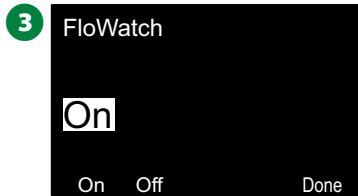

NOTE: Once FloWatch is enabled we recommend that you Learn Flow or manually enter flow for all stations and FloZones if you have not already done so. This will allow FloWatch to react appropriately to the High Flow and Low Flow settings.

Set Flow Limits

SEEF (High Flow) and SELF (Low Flow) Settings and Actions

To most effectively use FloWatch™, you will want to first set your High Flow and Low Flow thresholds and actions. SEEF (High Flow) stands for Seek and Eliminate Excessive Flow and deals with how you want the controller to respond when excessive flow is occurring, as might be the case with a mainline break or a valve which is stuck in the open position. SELF (Low Flow) stands for Seek and Eliminate Low Flow and deals with what the controller should do when low flow is present, as might be the case during a pump failure, municipal water supply issue or when a valve fails to open.

Set Up and Configure High Flow and Low Flow

Turn the controller dial to Flow Sensor



- At the FLOW SENSOR screen, press the Down Arrow key to select Set FloWatch, then press Next.
- At the FloWatch screen, press the Down Arrow key to select Set Flow Limit, then press Next.

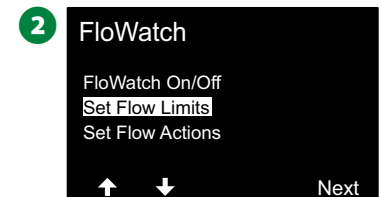
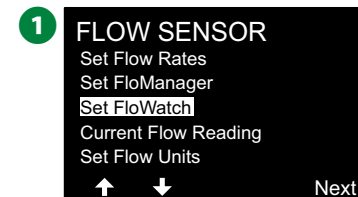

3 At the High Flow Settings screen, press the + and – keys to set the desired High Flow Threshold percentage (Max. 200%). Then press the Down Arrow key.

4 Press the + and – keys to set the desired High Flow settling time (Up to 10 minutes), then press Next.

- Press and HOLD keys to accelerate settings.

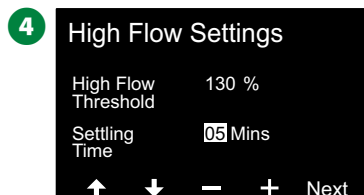
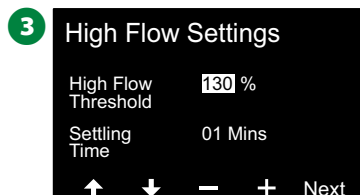

5 At the Low Flow Settings screen, press the + and – keys to set the desired Low Flow Threshold percentage (Max. 95%). Then press the Down Arrow key.

6 Press the + and – keys to set the desired Low Flow settling time (Up to 10 minutes).

- Press and HOLD keys to accelerate settings.

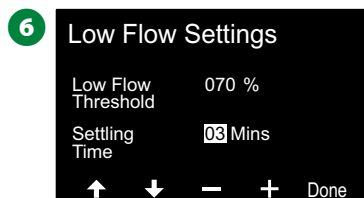
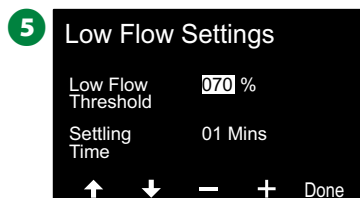

Set Flow Actions

There are 3 options available to Set Flow Actions during High or Low flow:

1. Diagnose & Eliminate
2. Shut Down & Alarm
3. Alarm Only



Turn the controller dial to Flow Sensor

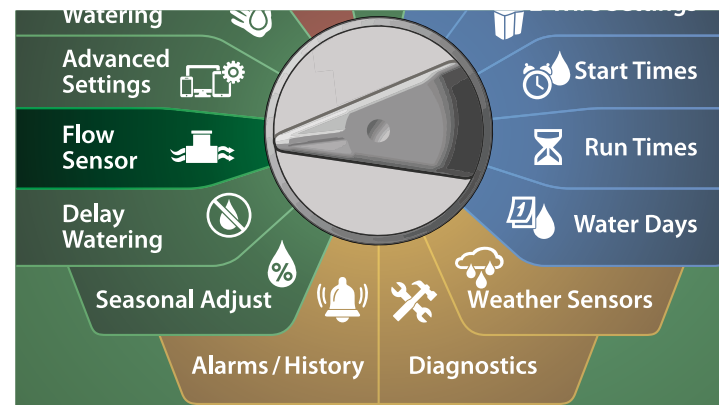

- 1** At the FLOW SENSOR screen, press the Down Arrow key to select Set FloWatch™, then press Next.
- 2** At the FloWatch screen, press the Down Arrow key to select Set Flow Actions, then press Next.

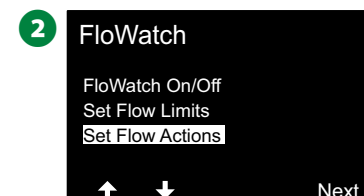
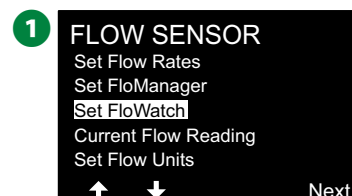

3 At the Action Under High Flow screen, press the + and – keys to set the desired option to occur under High Flow, then press next

4 At the Action Under Low Flow screen, press the + and – keys to set the desired option to occur under Low Flow, then press next

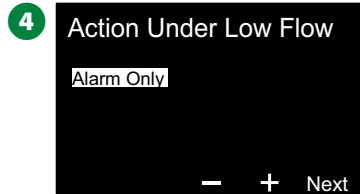
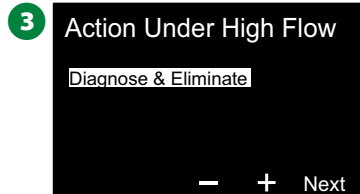

5 At the Re-enable time screen, press the + and – keys to set the desired number for hours (from 0 to 23). Press the Arrow keys to navigate between the number setting fields. Set the minutes (from 0 to 59).

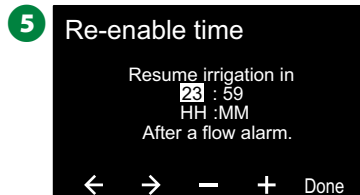

Current Flow Reading

Occasionally it may be useful to check the current flow rate in a particular FloZone and how that compares to previously learned or user input station flow rates.

 Turn the controller dial to Flow Sensor



1 At the FLOW SENSOR screen, press the Down Arrow key to select Set Current Flow Reading, then press Next.

2 At the View Current Flow screen, press the + and – keys to select the desired FloZone number. Current and expected flow will show.

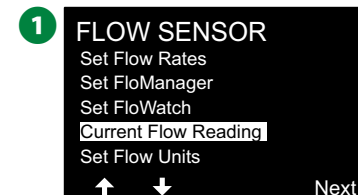

 NOTE: Expected flow is from previously user-entered or learned station flow rates. The deviation or percentage comparison of current flow to expected flow will show so you can see how close each FloZone is to a High Flow or Low Flow condition (see Setting Up High Flow and Low Flow for more details).

Set Flow Units

To use Flo-Manager® or FloWatch™ with the ESP-LXIVM controller, you first need to set the measurement units for flow management.

 Turn the controller dial to Flow Sensor



- 1 At the FLOW SENSOR screen, press the Down Arrow key to select Set Flow Units, then press Next.
- 2 At the Set Flow Units screen, press the + and – keys to set the desired flow rate (M3/Hr, Auto, GPM, LPS, or LPM). Then press the Down Arrow key.

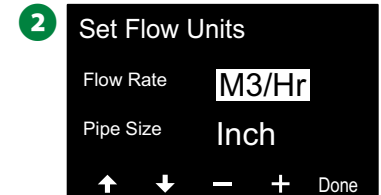
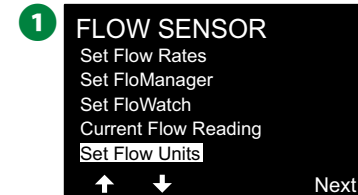

- 3 Press the + and – keys to set the desired pipe size measurement (Auto, Inch, or mm).

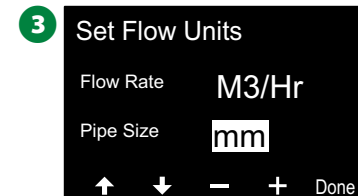

 NOTE: If Auto is selected, Flow Rate will default to GPM when 60 Hz is detected and to LPS when 50 Hz is detected. Pipe Size will default to Inches on 60 Hz and to millimeters on 50 Hz.

Advanced Settings

Store/Recall Programs

The ESP-LXIVM controller comes standard with a simple to use backup programs feature.

Backup Programs allows you to save your programs as Contractor Default and then recall them at a later time. It also includes a Delayed Recall feature that lets you save a normal irrigation schedule as the Backup and then restore it later automatically. This may be useful for new seed or sod where frequent irrigation can be programmed to occur until a set date when Delayed Recall automatically returns the controller programming to the normal irrigation schedule.

NOTICE

The Backup Programs feature saves and restores ALL irrigation programming in ALL programs.

Store Programs



Turn the controller dial to Advanced Settings

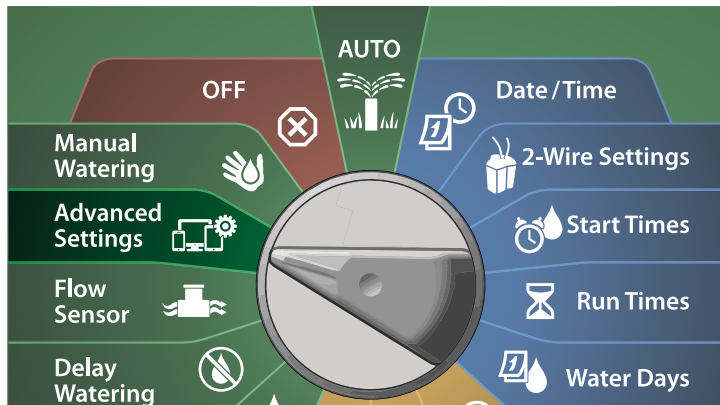

- 1 At the IQ / ADVANCED screen, with Store/Recall Programs selected, press Next.
- 2 At the Program Options screen, with Store Programs selected, press Next.

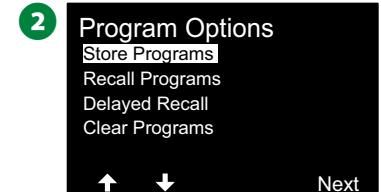
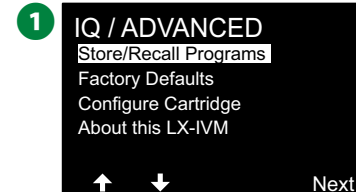

- 3 At the confirmation screen, press and HOLD the Yes key for 4 seconds to Store All Programs. If you're not sure, press No.
- 4 A confirmation screen shows the process is running.

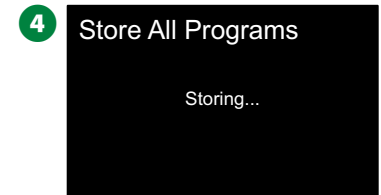
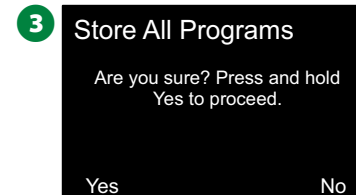

- 5 A confirmation screen shows the process is complete.

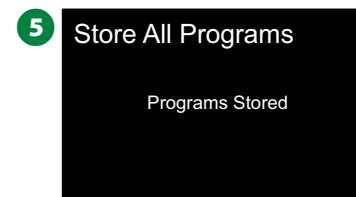

Recall Programs



Turn the controller dial to **Advanced Settings**

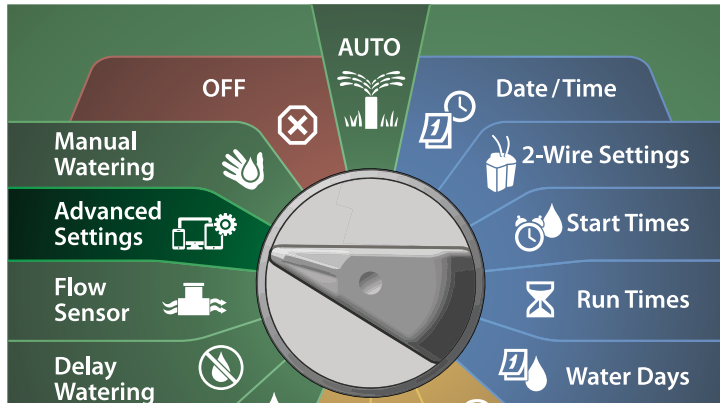

- 1 At the IQ / ADVANCED screen, with Store/Recall Programs selected, press Next.
- 2 At the Program Options screen, press the Down Arrow key to select Recall Programs, then press Next.

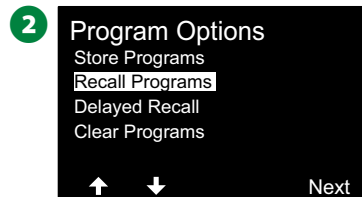
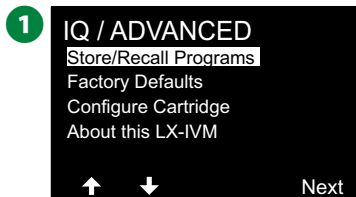

- 3 At the confirmation screen, press and HOLD the Yes key for 4 seconds to Recall All Programs. If you're not sure, press No.
- 4 A confirmation screen shows the process is running.

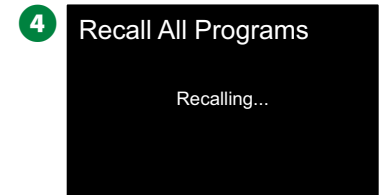
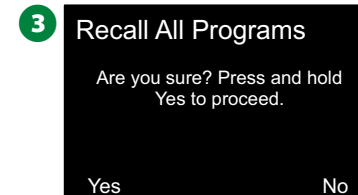

- 5 A confirmation screen shows the process is complete.



Delayed Recall Programs

Use the Delayed Recall feature to automatically replace the currently loaded programs with a previously stored program at a future date.

NOTICE

Once current programs have been replaced with the Delayed Recall feature, they can not be restored.



Turn the controller dial to Advanced Settings

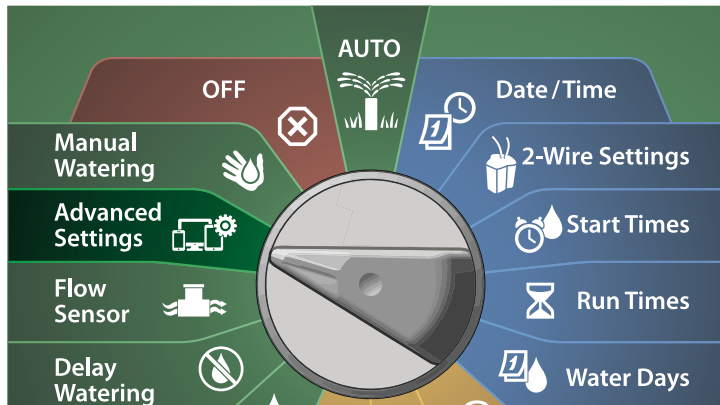

- 1 At the IQ / ADVANCED screen, with Store/Recall Programs selected, press Next.
- 2 At the Program Options screen, press the Down Arrow key to select Delayed Recall, then press Next.

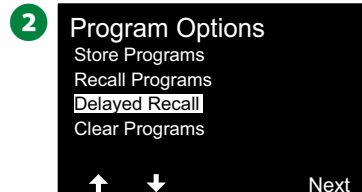
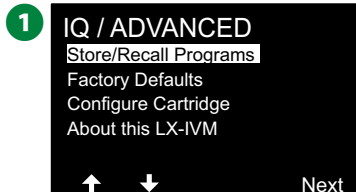

- 3 At the Recall Delay screen, press the + and – keys to set the number of days (from 0 to 90 days) before Contractor Defaults are restored. For example, set it to 7 days if you want your original programs to be restored in one week.

- To clear a Delayed Recall, set the number of days to 0.

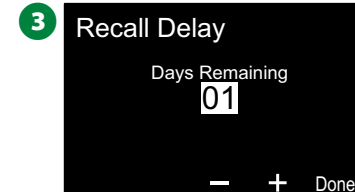

Clear Program Information

The ESP-LXIVM controller allows you to clear an individual Program, all of your Programs or Restore the controller to it's factory default condition.

NOTICE

It's recommended to back up your Programs before clearing them. The LX-IVM controller's built in Store Programs feature can backup one set of programs. See "Store/Recall Programs" on page 89 for more details.

 NOTE: Irrigation start days, Start Times and station Run Times will no longer be present for the cleared Programs. If no Programming exists then an Alarm will be shown. See "Alarms" on page 21 for more details.

Clear Individual Program



Turn the controller dial to Advanced Settings

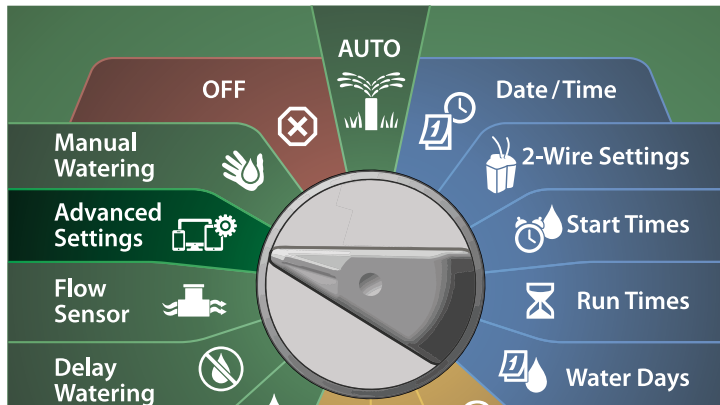

- 1 At the IQ / ADVANCED screen, with Store/Recall Programs selected, press Next.
- 2 At the Program Options screen, press the Down Arrow key to select Clear Programs, then press Next.

 NOTE: If the desired program is not selected, press the Program Select button to choose the desired program. See "Program Select Button" on page 39 for more details.

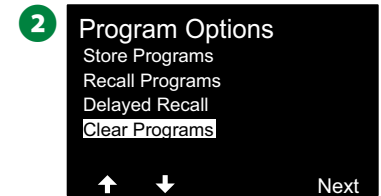
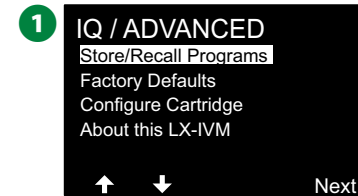

- 3 At the Clear Programs screen with Individual Programs selected; press Next.
- 4 At the confirmation screen, press and HOLD the Yes key for 4 seconds to Clear Programs. If you're not sure, press No.

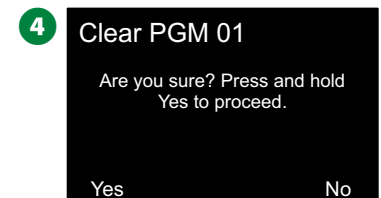
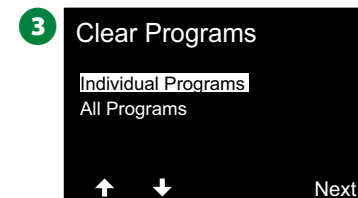

- 5 A confirmation screen shows the process is complete.

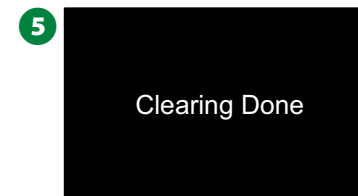

 Change the Program Select switch and repeat this process to clear other Programs.

Clear All Programs



Turn the controller dial to Advanced Settings

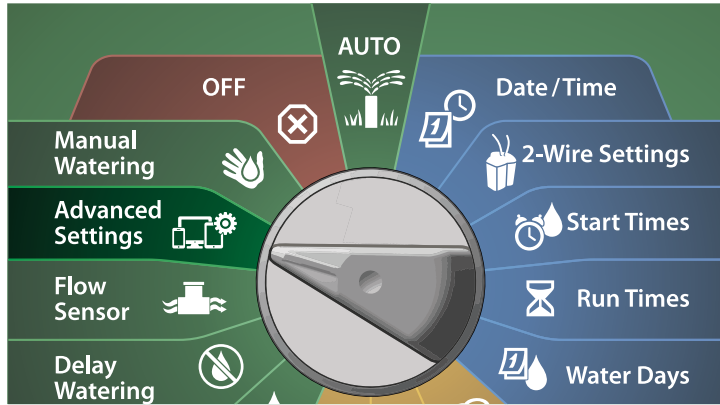

- 1 At the IQ / ADVANCED screen, press the Down Arrow key to select Store/Recall Programs, then press Next.
- 2 At the Program Options screen, press the Down Arrow key to select Clear Programs, then press Next.



NOTE: If the desired program is not selected, press the Program Select button to choose the desired program. See "Program Select Button" on page 39 for more details.

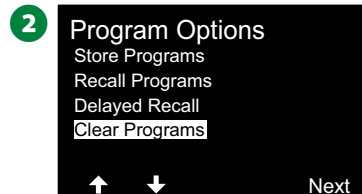
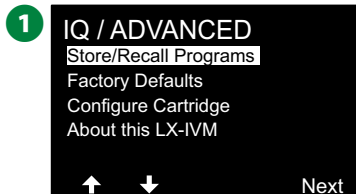

- 3 At the Clear Programs screen, press the Down Arrow key to select All Programs, then press Next.
- 4 At the confirmation screen, press and HOLD the Yes key for 4 seconds to Clear All Programs. If you're not sure, press No

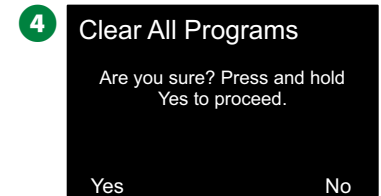
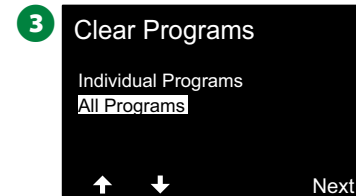

- 5 A confirmation screen shows the process is complete.

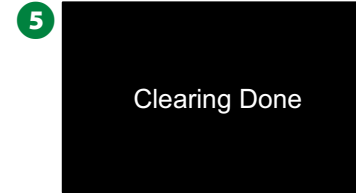

Factory Defaults

Restore the ESP-LXIVM controller's factory default settings.



Turn the controller dial to Advanced Settings

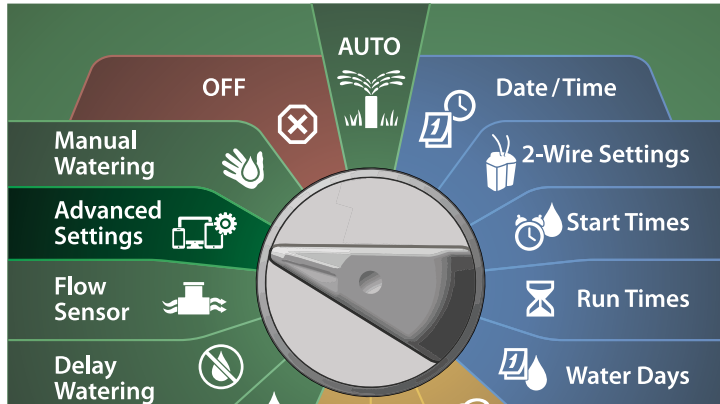

- 1 At the IQ / ADVANCED screen, press the Down Arrow key to select Factory Defaults, then press Next.
- 2 At the confirmation screen, press and HOLD the Yes key for 4 seconds to Restore Factory Defaults. If you're not sure, press No.

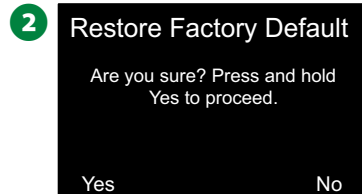
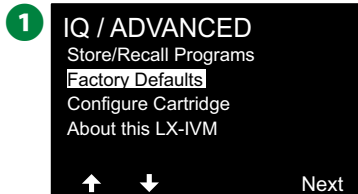

- 3 A confirmation screen shows the process is complete.

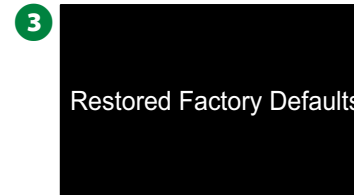

NOTICE

Be very careful about using the Factory Default as an option as all previous settings, including 2-Wire Device addresses, will be permanently cleared from system memory. Consider using the Clear All Programs option instead so that your 2-Wire Device addresses will not be erased.

About this LX-IVM



Turn the controller dial to **Advanced Settings**

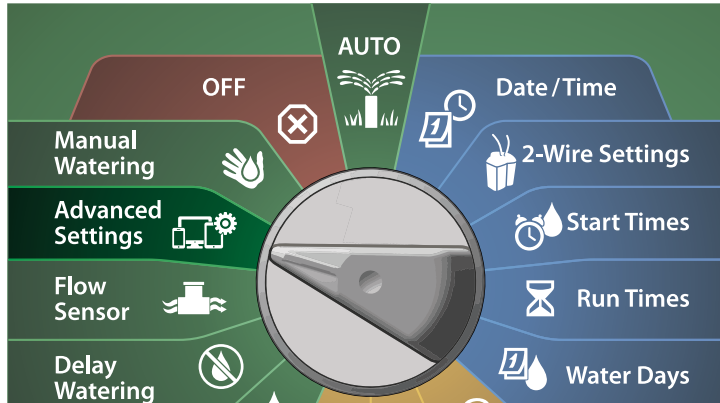

- 1 At the IQ / ADVANCED screen, press the Down Arrow key to select About this LX-IVM, then press Next.
- 2 The ABOUT LX-IVM PRO screen appears with an overview of your LX-IVM PRO including the information of the version, front panel, cartridge, and slots of your LX-IVM.

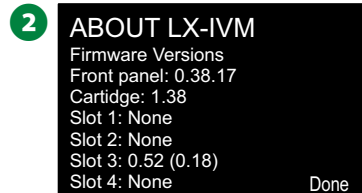
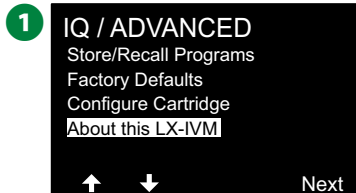

Manual Watering

The ESP-LXIVM controller allows you to manually start a station, a program, or to open a Normally Closed Master Valve (NCMV) to provide water to a FloZone for manual watering.

Start Station

 NOTE: Manual Watering > Start Station will pause currently running programs.

 NOTE: Ensure device addresses are present and entered correctly prior to Manual Station or Manual Program operations.

Turn the controller dial to Manual Watering

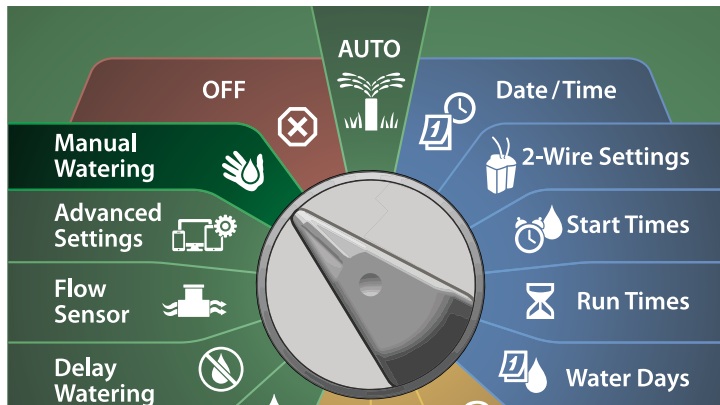

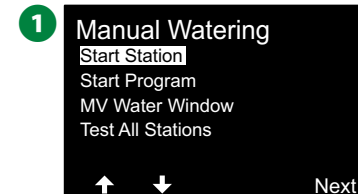

- 1 At the Manual Watering screen, with Start Station selected, press Next.
- 2 At the Run Time - Station screen, press the + or – key to select the desired station (from 1 to 240) to run manually.

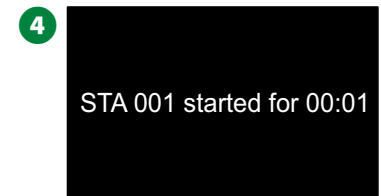

- 3 Press the Arrow keys to set the station Run Time (from 0 hours, 1 minute to 96 hours). Press the Run key to start irrigation for that station.
 - Press and HOLD keys to accelerate settings.
- 4 A confirmation screen shows that irrigation has started.



 Repeat this process to manually water other stations.

 NOTE: Stations will run sequentially in the order in which they were selected.

- 5 To view the Station while running, turn the controller dial to the AUTO position. Press the + or – keys to add or subtract minutes from the run time for the currently running station. To advance to the next station in a program, press the Adv key.

Start Program

 Turn the controller dial to Manual Watering

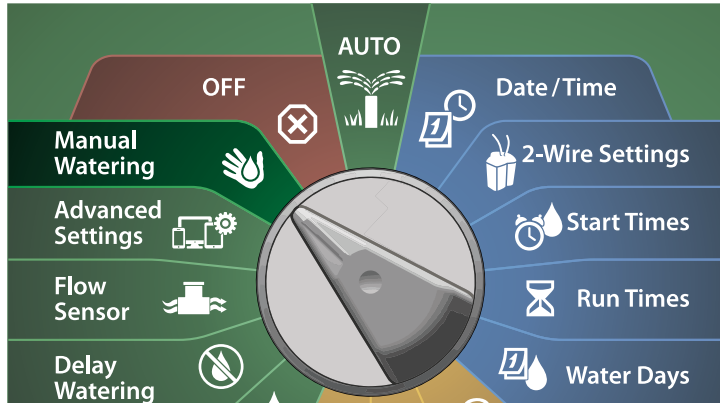

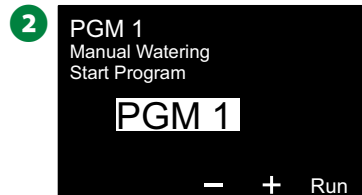
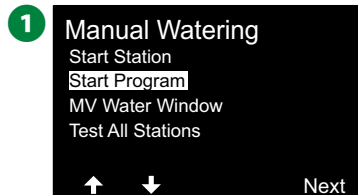

- 1 At the Manual Watering screen, press the Down Arrow key to select Start Program, then press Next.
- 2 At the Manual Watering Start Program screen, press the + and - keys to set the desired program, then press Run to start irrigation.

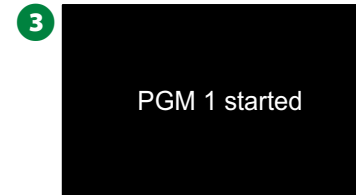

- 3 A confirmation screen shows that irrigation has started.



-  Repeat this process to manually start other Programs.
-  NOTE: Programs will run sequentially in the order in which they were selected.

Master Valve Water Window

Sometimes you may want to use quick coupling valves or other manual watering methods during times when you are not irrigating. To ensure that these devices have water, you can set up an MV Water Window. The MV Water Window works the same way as other Water Windows, but instead of allowing irrigation it simply opens Normally Closed Master Valves (NCMV) and allows a user-defined flow rate to coordinate with flow sensing.

Set Up MV Water Window

 Turn the controller dial to Manual Watering

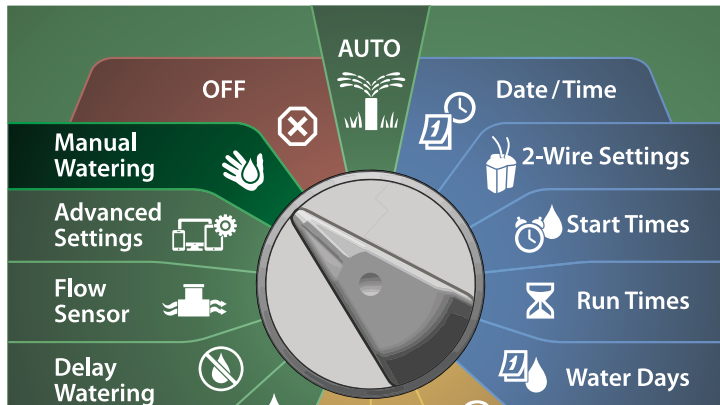

- 1 At the Manual Watering screen, press the Down Arrow key to select MV Water Window, then press Next.
- 2 At the MV Water Window screen, with Set MV Water Window selected, press Next.

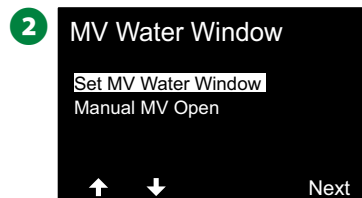
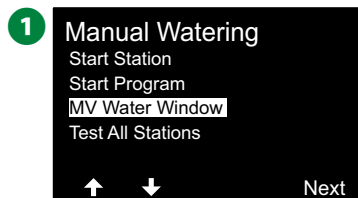

- 3 Press the + and – keys to set the MV Water Window Start time. Press the Arrow keys to navigate between the number setting fields.
- 4 Press the + and – keys to set the time when the End time. The duration of your MV Water Window calculates automatically, then press Next.
 - Press and HOLD keys to accelerate settings.

 NOTE: To clear a previously set MV Water Window, press the + and – keys to set both the Open and Close times to OFF (between 11:59 PM and 12:00 AM).

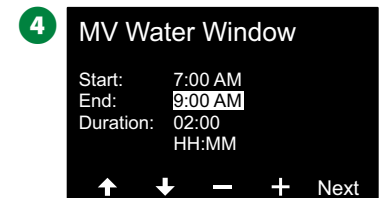
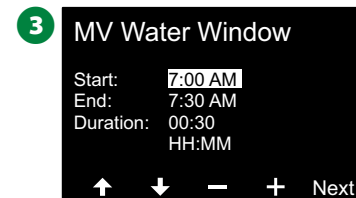

- 5 At the MV Water Window Days screen, press the Yes key to allow MV Manual Watering to occur on a given day or press No to exclude that day. Press Next to advance past Sunday.
- 6 At the Water Window MVs screen, press the Yes key to include the selected Master Valve in the Water Window, or press No to exclude that MV.

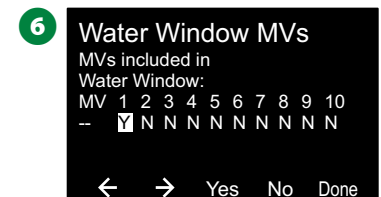
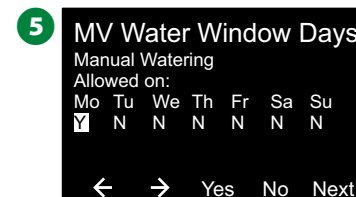

Manual MV Open

Occasionally it may be necessary to provide water to the system for unscheduled tasks. The Open MV feature allows you to leverage settings, such as the maximum additional flow rate, from your MV Water Window to open MVs for a short time.

Turn the controller dial to Manual Watering

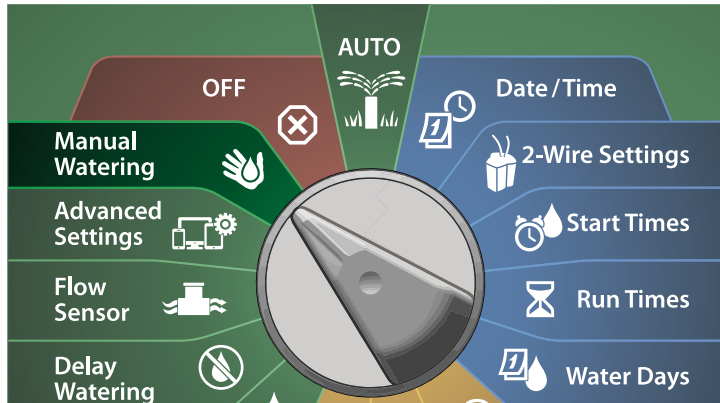

- 1 At the Manual Watering screen, press the Down Arrow key to select MV Water Window, then press Next.
- 2 At the MV Water Window screen, press the Down Arrow key to select Manual MV Open, then press Next.

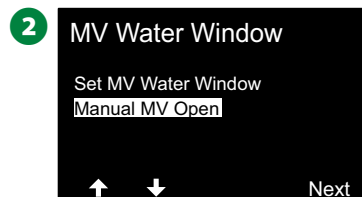
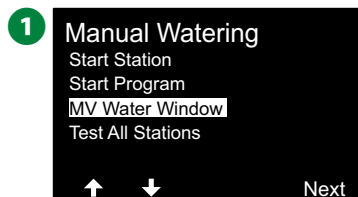

- 3 The Manual MV Open screen appears, showing all MVs that were previously selected to be included in the MV Water Window. Press Next.
- 4 At the Manual MV Open screen, press the + and – keys to set the duration (in hours and minutes) for the MV to be open, then press Start.
 - Press and HOLD keys to accelerate settings.

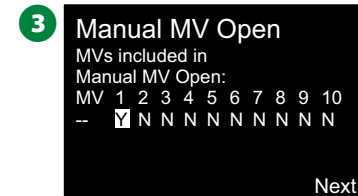

- 5 The Confirmation screen appears.

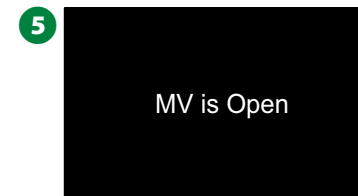

Test All Stations

You can test all stations connected to the controller by running each of them in station number sequence.

 Turn the controller dial to Manual Watering

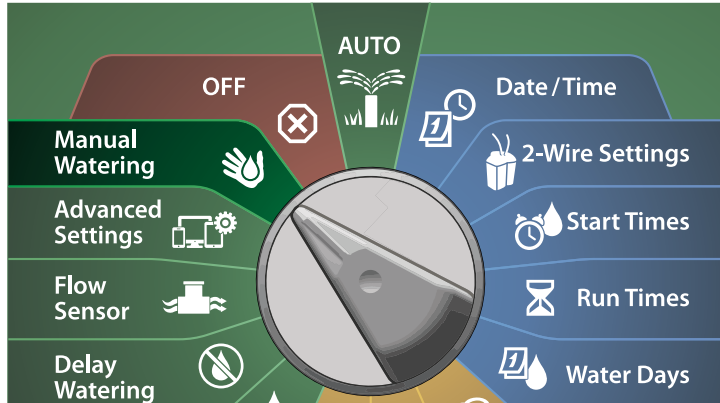

- 1 At the Manual Watering screen, press the Down Arrow key to select Test All Stations, then press Next.
- 2 At the Test All Stations screen, press the + and – keys to set the Test Time (from 1 to 10 minutes), then press Run.

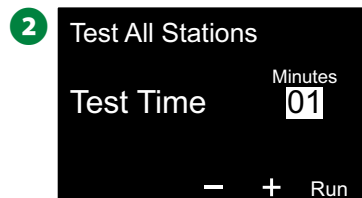
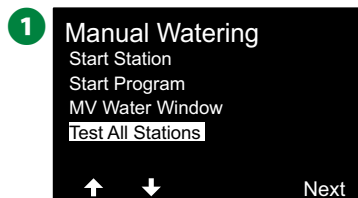

- 3 The Confirmation screen with Station Test Started appears.

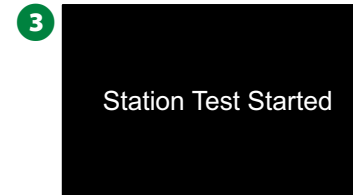

OFF

Turn off irrigation, master valves or the 2-Wire path.

Adjust Display Contrast

For better visibility, you can adjust contrast values of the controller display from 1-12 in the OFF position.

 Turn the controller dial to OFF

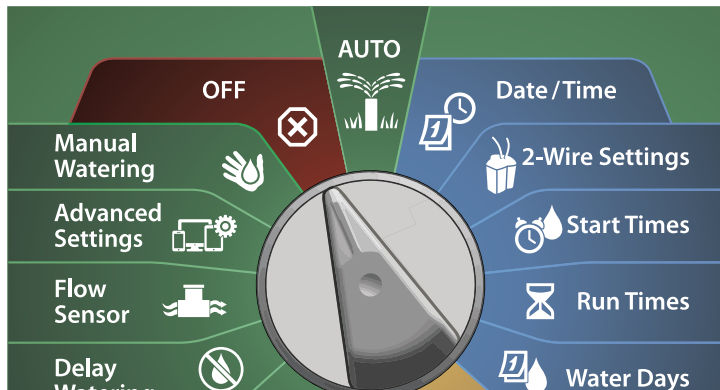

1 At the All Watering Off screen, press the + and – keys to adjust contrast up or down (from 0 to 12).

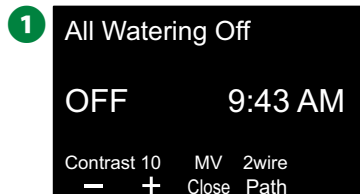

Close Master Valves

Closes all master valves, disabling irrigation.

NOTICE

Using the MV Close function will disable all irrigation functions.

 NOTE: The Close Master Valves function closes Normally Open Master Valves. Normally Closed Master Valves remain closed.

 Turn the controller dial to OFF

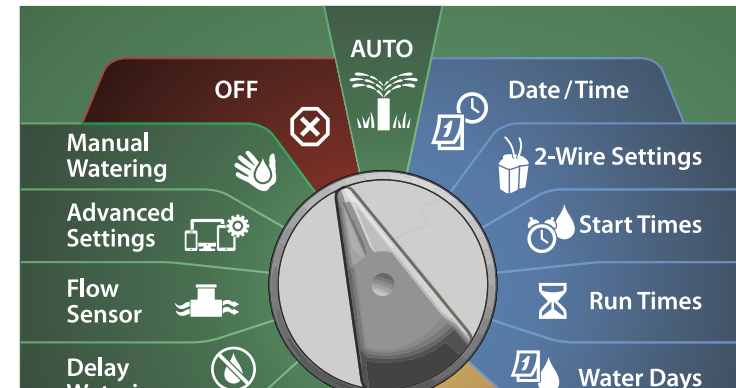

1 At the All Watering Off screen, press the MV Close key.

2 At the confirmation screen, press and HOLD the Yes key for 4 seconds to Close Master Valves. If you're not sure, press No.

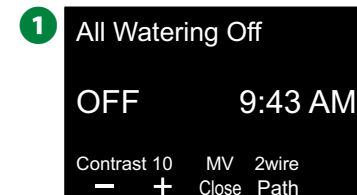

- 3 A confirmation screen shows the MV has closed.
- 4 The OFF dial position screen will now show the message "All MVs Closed. To cancel and restore irrigation functions, turn the dial to AUTO".

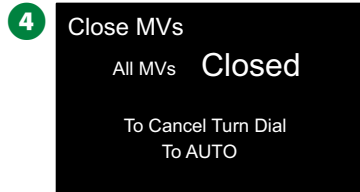

Turn Off 2-Wire path

Sometimes you may want to turn off the 2-Wire path, such as when you're maintaining your system. The ESP-LXIVM controller lets you do this automatically so you do not need to un-wire the 2-Wire path from the connection lugs.

CAUTION

Always turn off 2-Wire path before maintaining hardware connected to the 2-Wire path. The 2-Wire path is always powered even when irrigation is not scheduled.

NOTICE

Irrigation functions, including: flow sensors, weather sensors and valves will be non-operational when the 2-Wire path is powered down.

Power Down or Restore Power to the 2-Wire path

 Turn the controller dial to OFF

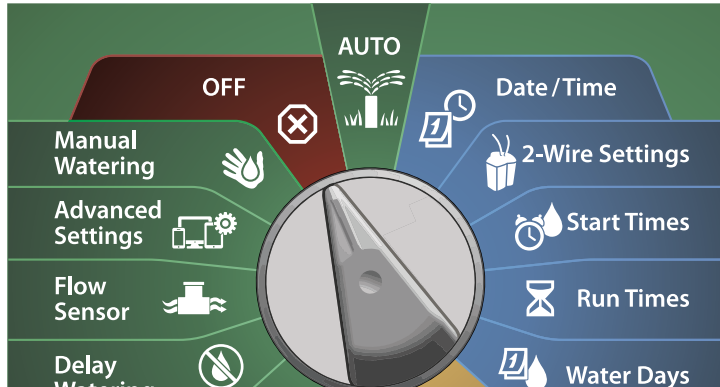

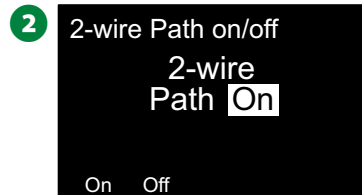

- 1 At the All Watering Off screen, press the 2-Wire path key.
- 2 The 2-Wire path On/Off screen will appear. Normally the 2-Wire path will be ON, unless you have previously turned it off. Press the Off key.

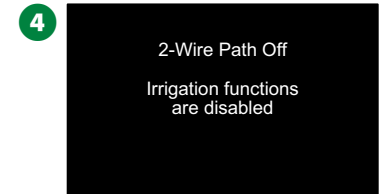

- 3 At the confirmation screen, press and HOLD the Yes key for 4 seconds to turn off the 2-Wire path. If you're not sure, press No.
- 4 A confirmation screen shows status of the 2-Wire path.



 Repeat this process and press the On key to restore power to the 2-Wire path.

 NOTE: It's not necessary to leave the controller dial in the OFF position when the 2-Wire path is off. You can still change Programs or perform other tasks. But while the 2-Wire path is powered down, the controller's alarm light will be lit and a 2-Wire path Off message will be shown whenever the controller dial is at the OFF or AUTO dial positions.

Installation

Install the Controller

This section explains how to mount the ESP-LXIVM controller on a wall (or mounting surface) and connect the wiring.

 NOTE: An optional metal cabinet (LXMM) and pedestal (LXMMPED) or stainless steel cabinet (LXMM-SS) and pedestal (LXMMPED-SS) are also available for the LX-IVM controller. If you intend to purchase those options then follow the installation instructions included with those items and proceed to the Install Modules section below.

⚠ WARNING

This controller must be installed in compliance with local electrical codes.

Installation Checklist

When installing the ESP-LXIVM controller for the first time, it is recommended that you complete the following steps in order.

For your convenience a check-off box is provided for each step.

- Check box contents page 104
- Select a location page 105
- Gather installation tools page 105
- Mount the controller page 107
- Install IVM 2-Wire interface module page 108
- Connect 2-Wire path(s) page 109
- Connect source power page 112
- Complete the installation page 114

Check Box Contents

All components below are included with your ESP-LXIVM controller and are required for installation. If anything is missing, please contact your distributor before proceeding.

- 1** ESP-LXIVM controller
- 2** Controller cabinet keys
- 3** Mounting hardware (5 screws, 5 plastic wall anchors)
- 4** Programming Guide
- 5** Field Device Installation Guide
- 6** Controller mounting template

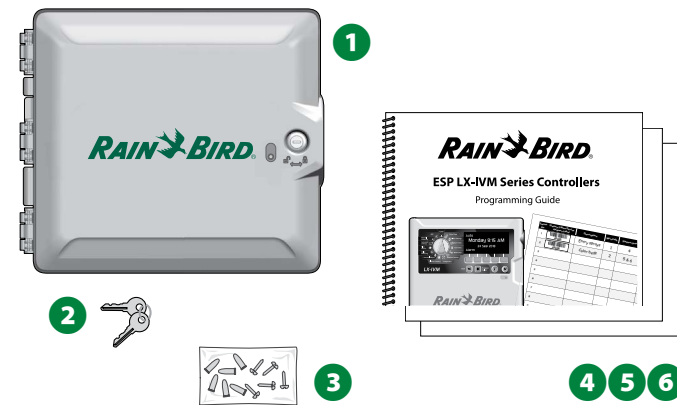

Box contents

Select Location for Controller

Select a location that:



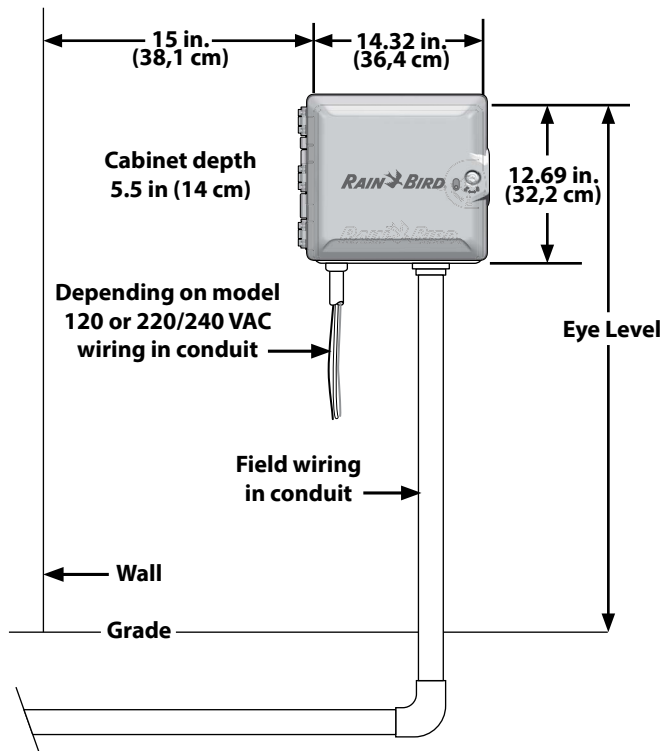





- Easily accessible and allows for comfortable viewing
- Has a flat wall surface
- Near 120 VAC or 230/240 VAC power source (depending on model)
- Is safe from potential vandalism
- Is outside the range of operating sprinklers

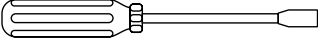
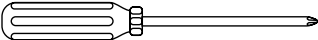

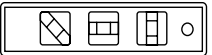
Select Controller Location

Gather Installation Tools

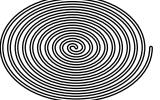
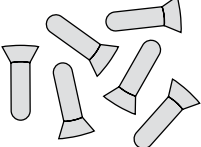
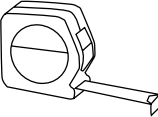
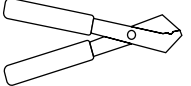
Before beginning installation, gather these tools and materials:

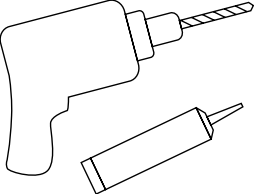
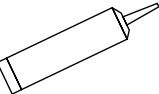
- Slotted head screwdriver 
- Phillips head screwdriver 
- Thin blade screwdriver 
- Lineman's pliers 
- Torpedo level 
- Hammer 
- Grounding strap 
- 2-Wire maxi cable (#14 awg wire) 
- #8 Awg or #10 awg bare ground wire 
- DBR/Y-6 connectors 
- Tape measure 
- Wire stripper 
- Wire nuts 
- Marking pencil 
- Electric drill (or hammer drill if installing in masonry or concrete wall) 
- Waterproof caulking 

Access Controller Cabinet

Open or Remove Controller Front Panel

- 1 The controller comes with an outer door lock to deter vandalism and prevent unauthorized access to controller operations. If necessary, unlock the cabinet door using the supplied key.

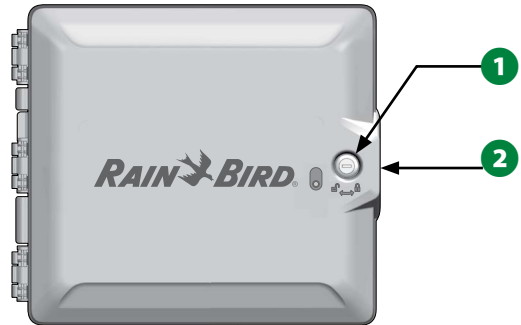

- 2 Grasp the handle on the right-hand-side of the outer cabinet and pull it towards you to open the door, swinging it to the left.
- 3 Grasp the handle on the right-hand-side of the controller front-panel and pull it towards you to open the cabinet, swinging it to the left.

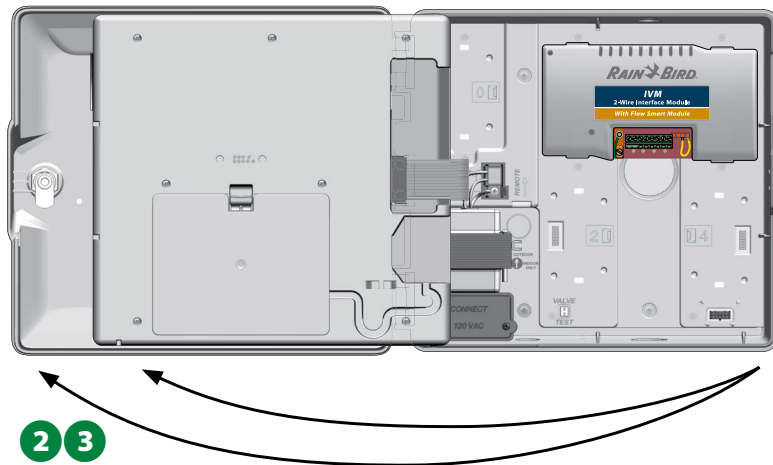

- 4 To remove the front panel: disconnect the ribbon cable from the front panel by gently pulling the connector out of the socket.

NOTICE

Be careful not to bend the pins in the sockets when attaching or detaching the ribbon cable.

- 5 Rock the front panel upward and nudge the bottom corner pin out of the lower pin-hole to remove the front panel.

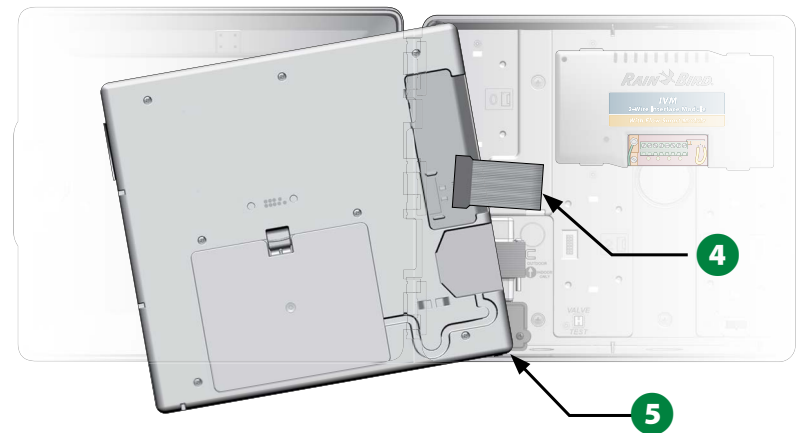

Mount Controller

 NOTE: Before mounting the controller, we recommend that you remove the controller front panel, plus the IVM 2-Wire Interface Module and/or any station modules if previously installed.

- 1 Using a level, tape the mounting template to the mounting surface at approximately eye level. Make sure that at least one of the five mounting hole marks is aligned on a wall stud or other solid surface.
- 2 Use a tapping tool (or nail) and hammer to tap pilot holes through the five mounting hole marks and into the mounting surface. Then remove the template and drill holes in the mounting surface, installing wall anchors if necessary.

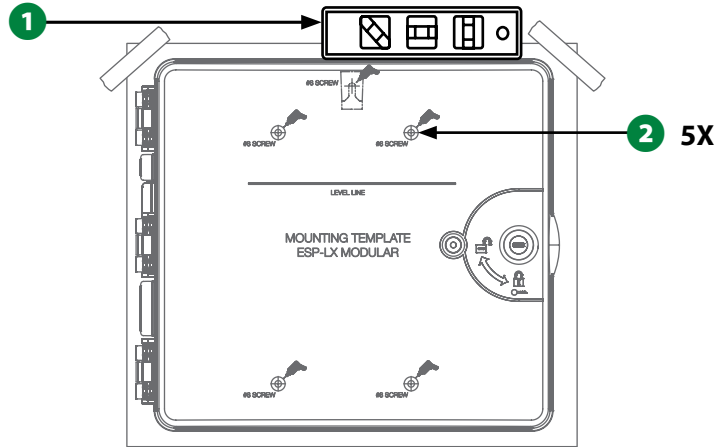

- 3 Drive the first screw into the topmost-center hole. Then hang the controller on the screw by the key-hole slot on the back of the cabinet.
- 4 Line up the controller cabinet mounting holes with the remaining pilot holes and drive the four remaining screws through the cabinet back plane into the mounting surface.

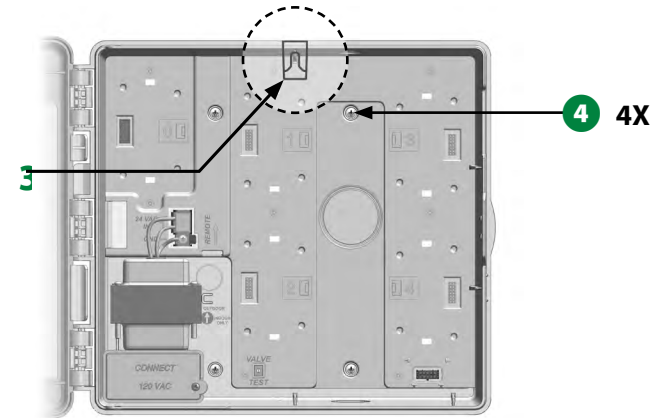

Install IVM 2-Wire Interface Module

An IVM 2-Wire Interface Module is required for operation and is included with every LX-IVM controller. The IVM Module powers and provides an interface from the controller to the 2-Wire path.

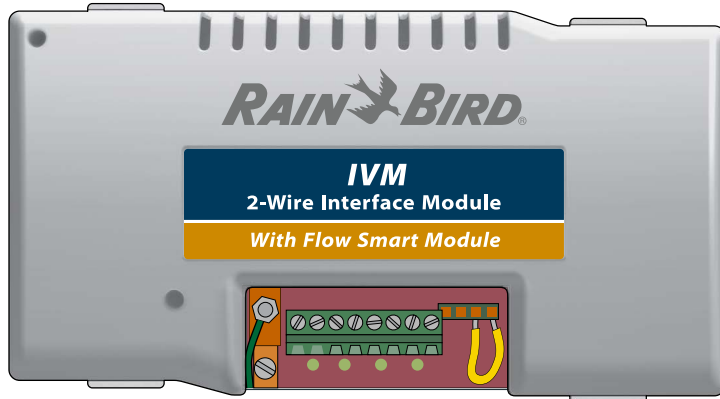

IVM 2-Wire Interface Module

The IVM 2-Wire Interface Module must be installed horizontally in the controller cabinet, as shown. The module can be connected to either the top set of connectors (module slots 1 and 3) or the bottom set of connectors (module slots 2 and 4) on the controller backplane.

NOTICE

Be careful not to bend the pins in the sockets when installing the module.

- 1 Orient the connectors on the bottom of the module with the connection sockets on the controller backplane.

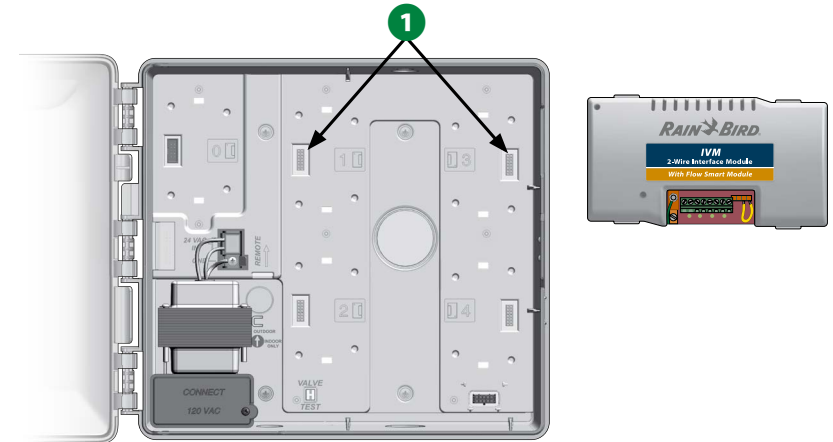

- 2 Carefully fasten the module onto the controller backplane, pressing firmly until it snaps into place.
- 3 Connect the green ground wire to the ground spade connector on the left side of the controller backplane.

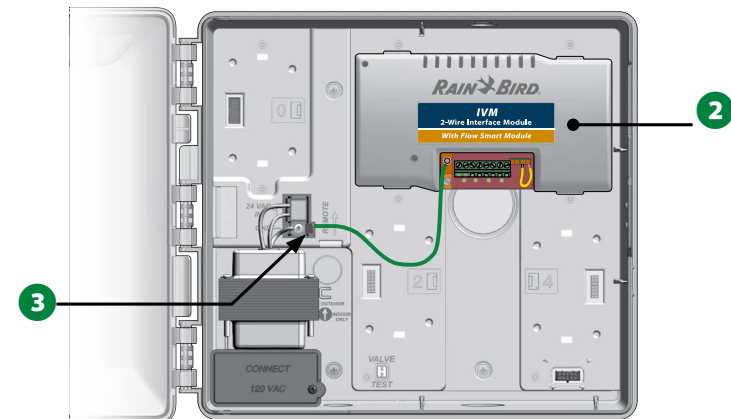

-  **NOTE:** To remove the module again, press in on the (four) release keys on either side of the module.

Connect Field Wiring

The ESP-LXIVM controller can support up to four 2-Wire path connections. The controller will manage multiple 2-Wire connections as a single 2-Wire path. Rain Bird® requires use of MAXI Cable, #14 AWG, as your 2-Wire communications cable.

Connecting the 2-Wire Cable

NOTICE

Do not install the communications cables in the same conduit as the 2-Wire path wiring.

- 1 Strip away approximately 6 in (15,24 cm) of the cable's outer sheathing, then strip approximately 5/8 in (1,58 cm) of the insulation away from the ends of the two inner wires. See Wire Splices and 2-Wire Device Connections for more details on the correct way to splice wire connections.
- 2 If additional wiring access is needed, knock out one or more of the knockouts on the bottom of the controller cabinet. Using a screwdriver or other pointed tool, center the point of the tool on a "dimple" in one of the knockouts, then punch through and remove the knockout.

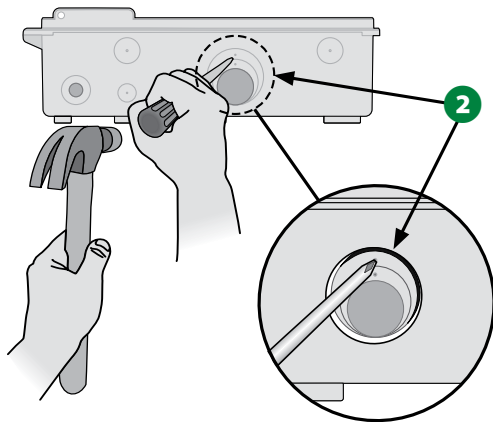

- 3 Screw a conduit fitting into the bottom of the cabinet, then attach conduit to the fitting.
- 4 Feed the 2-Wire communications cable through the conduit and into the controller cabinet.

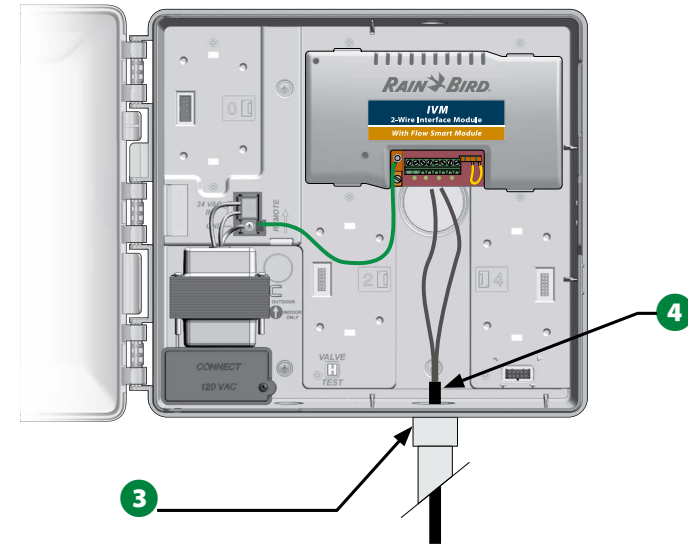

- Using a thin blade screwdriver, connect the two wire ends to a set of large 2-Wire path terminals on the ESP IVM 2-Wire Interface Module. When finished, tug gently on the wires to make sure the connections are tight.

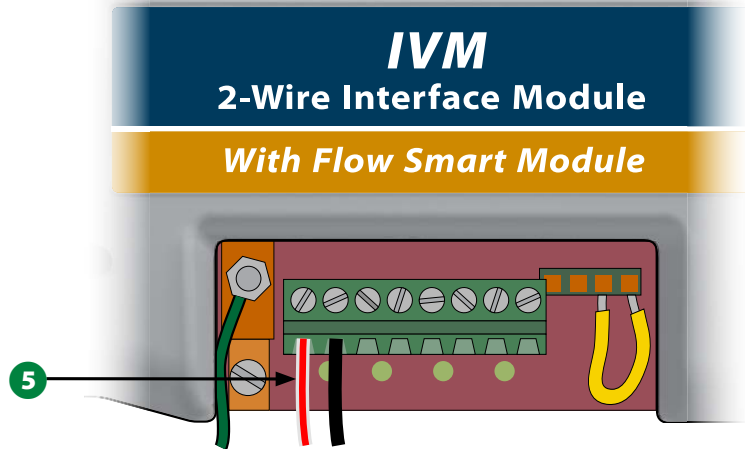

NOTICE

Wiring polarity must be correct in order for 2-Wire device to function properly. Connect the red wire to the terminal marked "RED1" and connect the black wire to the terminal marked "BLK1".

-  If you have multiple 2-Wire Paths then repeat this process to connect those wire ends to the other IVM 2-Wire Interface Module terminals as desired.

Surge Protection and Grounding

The ESP-LXIVM controller, IVM 2-Wire Interface Module and the 2-Wire path must be properly surge protected and grounded. Doing so can help prevent damage to the controller and irrigation system and also significantly reduce troubleshooting, repair time and expense. Failure to do so could result in failure of the controller and voiding the warranty.

CAUTION

The LX-IVM controller and the IVM 2-Wire Interface Module must be properly grounded. Doing so can help prevent damage to the controller and irrigation system and also significantly reduce troubleshooting, repair time and expense. Failure to do so could result in failure of the controller and voiding the warranty. Ensure that all grounding devices are compliant with local electrical codes.

ESP-LXIVM Controller

The ESP-LXIVM Decoder Controller is protected against electrical surges through the ground provided by the primary ground of the incoming power to the controller.

IVM 2-Wire Interface Module

- Connect #8AWG (10mm) or #10AWG (6MM) bare copper wire to the IVM Module ground lug.

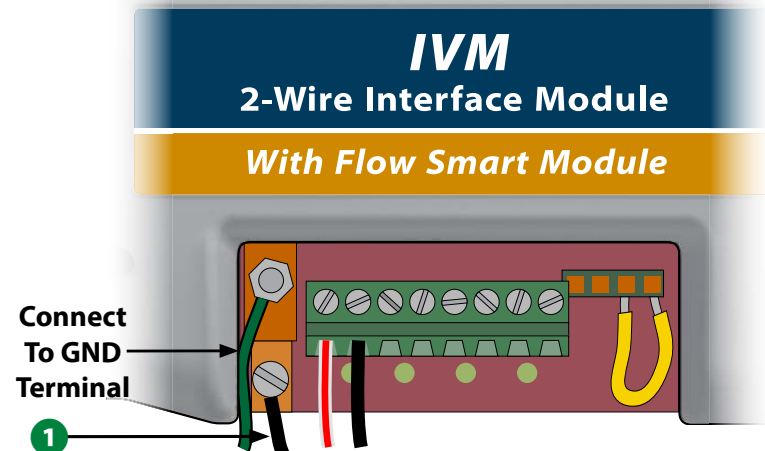

- 2 Connect the other end of the ground wire to a grounding rod(s) and/or plate with a resistance to ground of 10 ohms or less.

 **NOTE:** More information and guidelines on grounding electronic equipment in irrigation systems can be found on the American Society of Irrigation Consultants (ASIC) website at www.asic.org/Design_Guides.aspx. If you have any questions about properly grounding the controller, contact Rain Bird technical assistance at 1-866-544-1406.

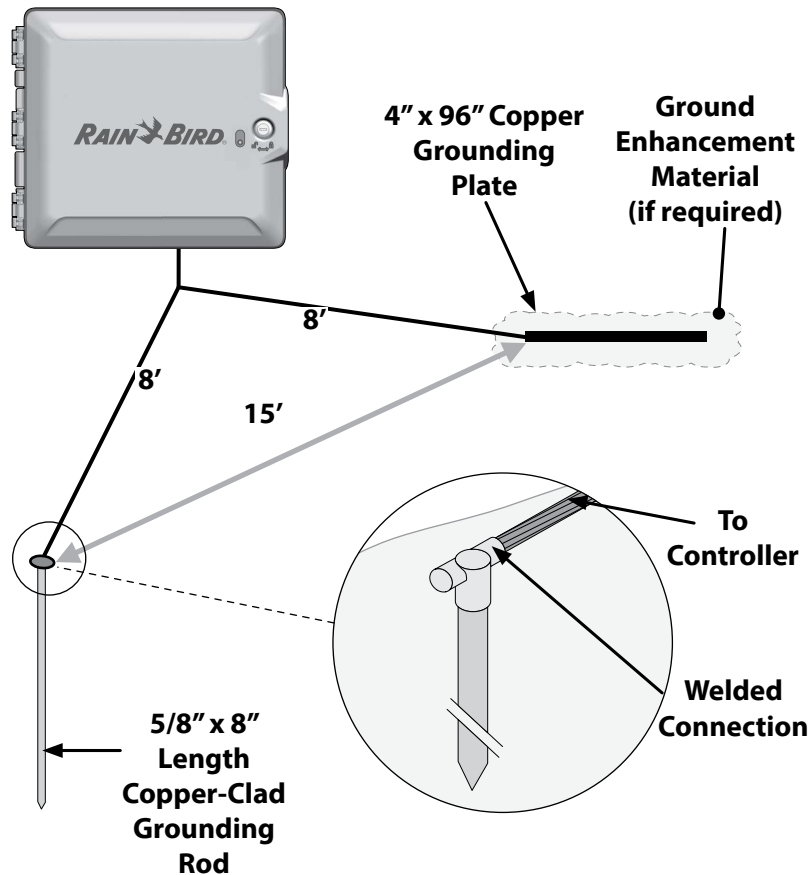

- 3 Once wiring is completed, fill top of conduit with waterproof caulking to prevent insect intrusion into the controller cabinet.

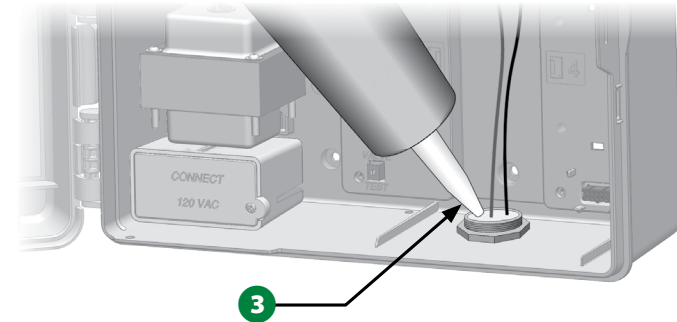

- 4 IVM-SD provides surge protection for the ESP-LXIVM Controller and the IVM 2-Wire interface module against electrical surges originating from each 2-Wire Path utilized. IVM-SD shall be spliced into each 2-Wire Path immediately where the IVM-SD can be taken to ground to the ESP-LXIVM Controller.

2-Wire Path

- 1 The 2-Wire path shall be surge protected and grounded with one IVM-SD every 500 feet or every 15 field devices, whichever is smaller.
- 2 Termination of 2-Wire Path – An IVM-SD shall be installed at the end of the 2-Wire path in a STAR configuration.

Connect Power to the Controller

Connect Power Source

The ESP-LXIVM controller has an internal transformer that reduces supply voltage (120 VAC in U.S. models; 230 VAC in International and European models; 240 VAC in Australian models) to 24 VAC to operate the 2-Wire Devices connected to the controller. You will need to connect power supply wires to the transformer's three wires.

⚠ CAUTION

Electric shock can cause severe injury or death. Make sure power supply is turned OFF before connecting power wires.

All electrical connections and wiring runs must be made according to local building codes.

- 1 With the front panel removed, locate the transformer wiring compartment in the lower left corner of the controller cabinet. Remove the screw on the right-hand side and pull the cover off to expose the wiring compartment.

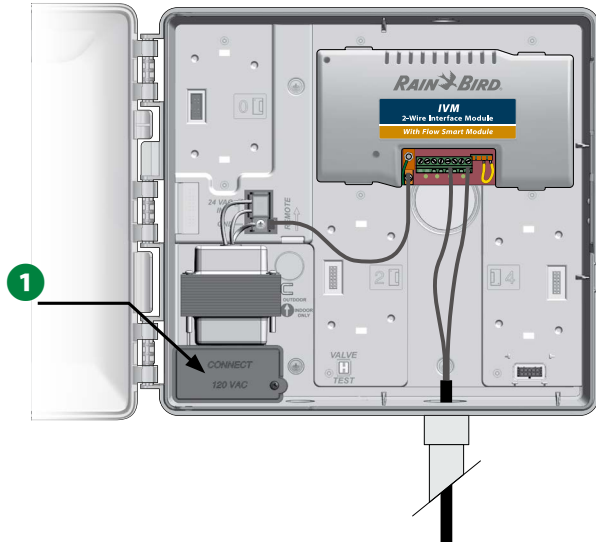

Wiring Connections	
120 VAC (US)	230 VAC (International)
Black supply wire (hot) to the black transformer wire	Black supply wire (hot) to the black transformer wire
White supply wire (neutral) to the white transformer wire	Blue supply wire (neutral) to the blue transformer wire
Green supply wire (ground) to the green transformer wire	Green-with-yellow-stripe supply wire (ground) to the green-with-yellow-stripe transformer wire

 NOTE: 240 VAC Australian models come equipped with an installed power supply cable.

- 2 Strip the insulation from the three incoming wires to expose approximately 1/2 in (13 mm) of bare wire.
- 3 Remove the knockout on the bottom of the cabinet below the transformer and attach a 1/2 in (13 mm) conduit fitting to the bottom entrance of the wiring compartment.

NOTICE

240 VAC (Australian) units do not require a conduit because the power supply cable is already installed.

- 4 Feed the three supply wires from the power source through the conduit into the wiring compartment.

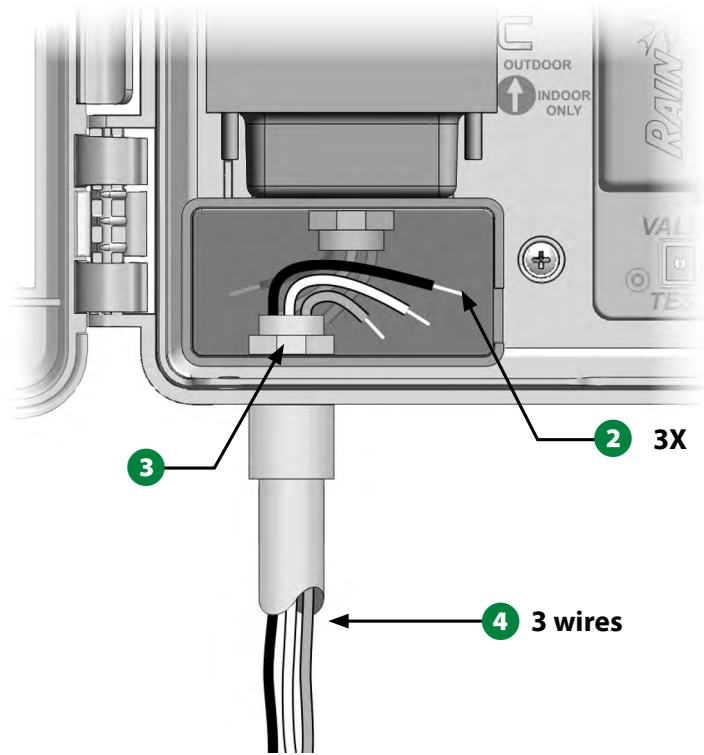

- 5 Using supplied wire nuts, connect the wires accordingly.

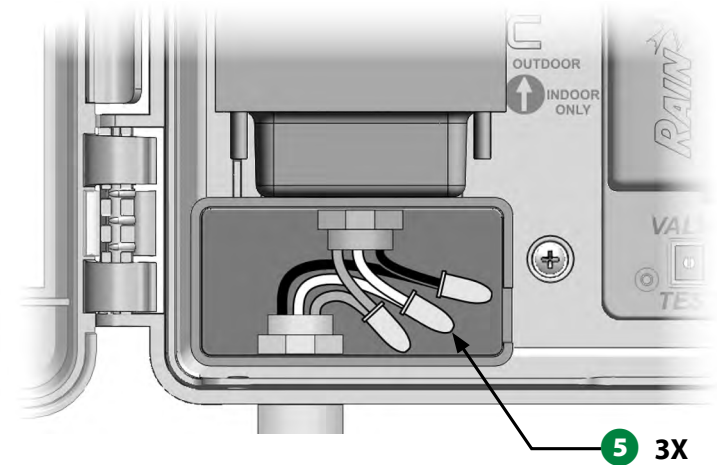

CAUTION

The ground wire **MUST** be connected to provide electrical surge protection. You will void the controller warranty if you do not ground the controller.

- 6 Once wiring is completed, fill top of conduit with waterproof caulking to prevent insect intrusion into the controller cabinet.

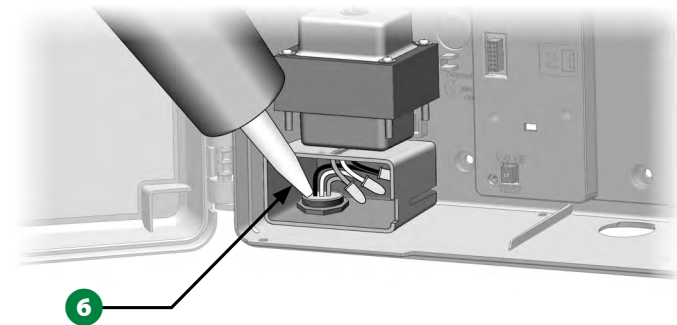

- 7 Verify that all connections are secure. Then replace the cover of the transformer wiring compartment and secure it with the screw.

Complete Installation

⚠ CAUTION

To prevent electrical shock, make sure all supply power is OFF before completing installation. Electrical shock can cause severe injury or death.

- 1 If you removed the front panel, reinstall it now by inserting the top corner pin into the top pin-hole, then push up and rock the bottom corner pin into the lower pin-hole.
- 2 Reconnect the ribbon cable to the front panel by gently pushing the connector into the socket.

NOTICE

Be careful NOT to bend the pins in the socket.

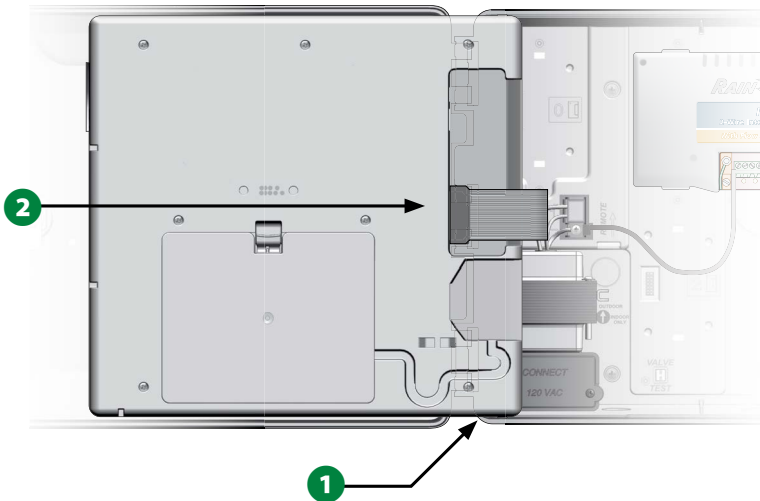

- 3 Turn on the power source.

 NOTE: The first time you power up the controller, the display will prompt you to select the language you wish to use. See "Language Select Button" on page 19 for more details.

Programming Under Battery Power

The ESP-LXIVM controller front panel can operate under battery power for remote programming. This feature is especially useful if the controller is installed in an area that is not easily accessible. It also lets you enter program information before installing the controller at the job site. All program information is stored in nonvolatile memory so it will be preserved indefinitely in the event of a power outage.

 NOTE: Under battery power, all programs in progress will continue to run in memory, but irrigation will not occur until power is restored. Without battery power, remaining programs will be cancelled.

- 1 Install a new 9-volt battery in the battery compartment in the back of the front panel.

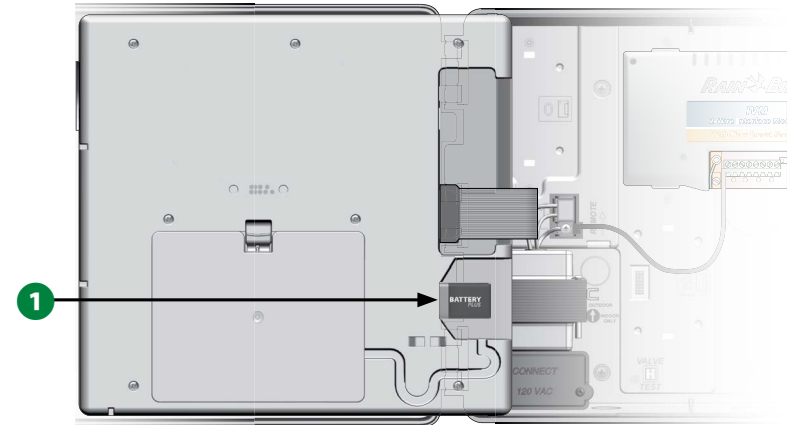

 NOTE: To perform remote programming, detach the front panel from the cabinet. See Access Controller Cabinet for more details.

NOTICE

The controller can not run irrigation or system diagnostics with the front panel detached. Re-connect the front panel to the controller's AC power source as soon as remote programming is completed.

IQ™ Central Control System

Rain Bird LX controllers including the LX-IVM can be optionally upgraded to communicate with the IQ Central Control System, providing remote communication capability for programming and monitoring multiple Rain Bird LX controllers from a computer, tablet, or smart phone.

IQ™ Network Communication Cartridge

These instructions guide you through installing an NCC Cartridge and configuring it for communication with the IQ Central Control System.

Three types of Network Communication Cartridges are available:

- IQNCCEN Ethernet Cartridge
- IQ3G-USA Cellular Cartridge
- IQNCCRS RS-232 Cartridge

NCC Cartridge Installation (Optional)

- 1 Open the controller outer door and inner front-panel. Locate the cartridge bay cover on the back of the front-panel and press down on the top-latch to remove it.

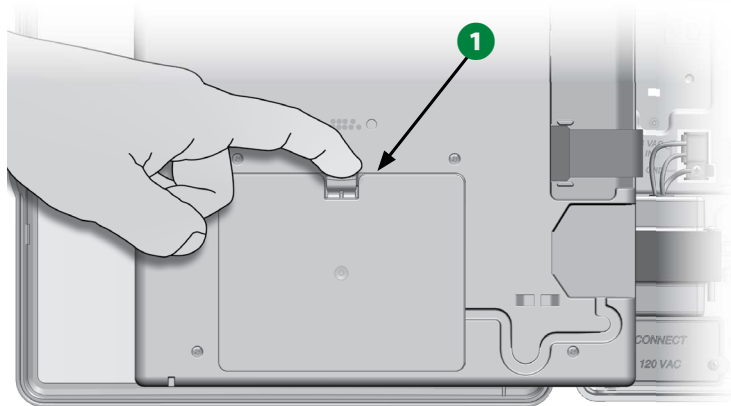

- 2 Connect the IQ Port cable or antenna to the cartridge. This cable or antenna provides communication to the IQ computer.

 **NOTE:** Follow instructions that came with your NCC Cartridge in order to connect to the IQ Central Control System.

- 3 Connect the NCC cartridge ribbon cable to the knife-edge connector inside the top-left corner of the cartridge bay.

NOTICE

Ensure that the RED edge of the ribbon cable is towards the LEFT side of the connector.

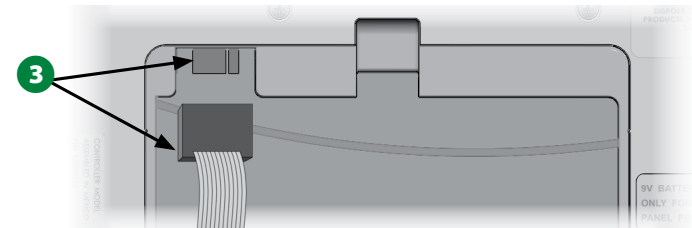

- 4 Orient the NCC cartridge so that the two bottom hinges fit into the hinge openings at the bottom of the cartridge bay. Then gently swing the cartridge up into place, snapping the top-latch.

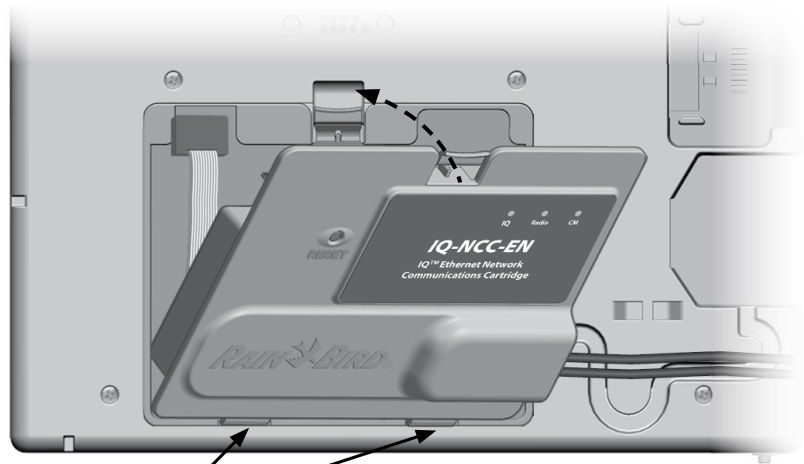

4

- 5 Route the Cartridge Connector Cable through the cable channel on the back of the controller front panel.

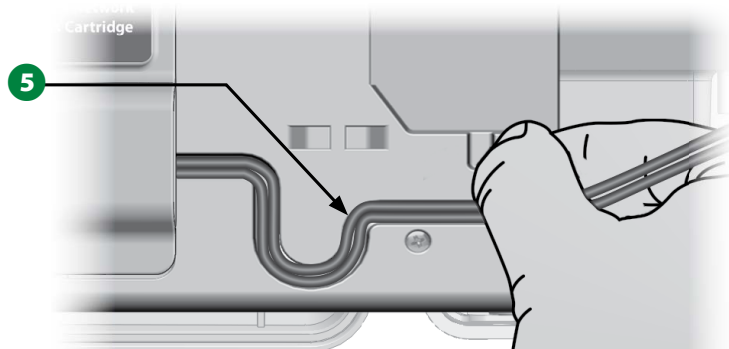

5

Configure NCC Cartridge

Setup Wizard



Turn the controller dial to **Advanced Settings**

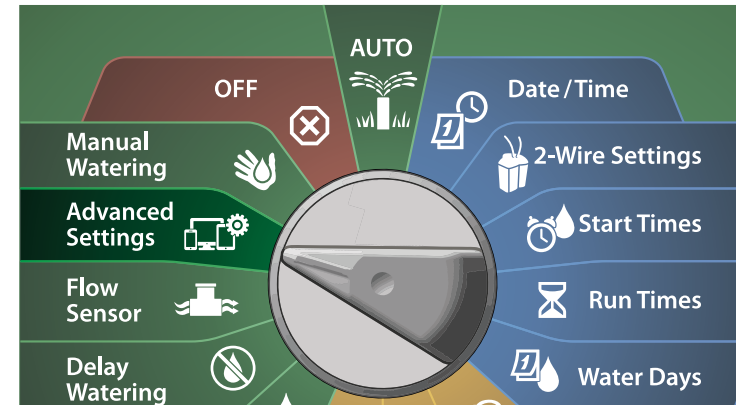

- 1 At the IQ / ADVANCED screen, press the Down Arrow key to select Configure Cartridge, then press Next.
- 2 At the IQNCC-RS Cartridge screen with Setup Wizard selected, press Next.

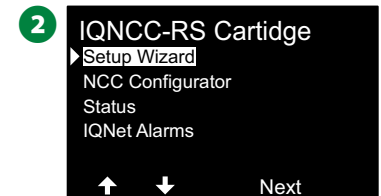
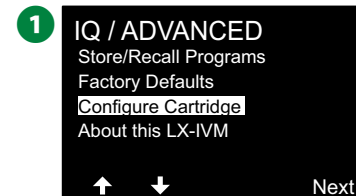

- At the IQNCC-RS Setup screen, press the + and – keys to select the type of satellite; then press Next.

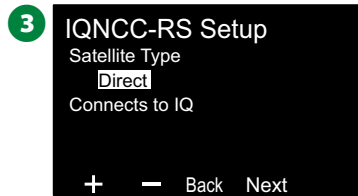

Direct Satellite

- A confirmation screen shows the address of the selected IQ Satellite. Press Next.
- At the IQ Port screen, press the + and – keys to select the desired port option; then press Next.

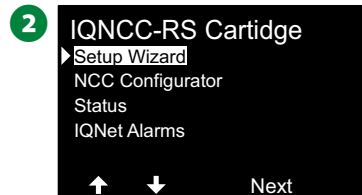
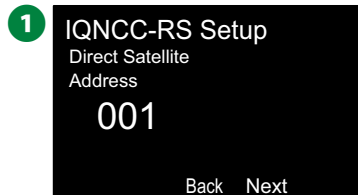

- For next steps, use the NCC Configurator to configure the new satellite.

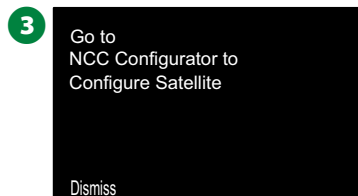

Server Satellite

- At the IQNCC-RS Setup screen, press the + and – keys to select Server satellite; then press Next.
- A confirmation screen shows the address of the selected IQ Satellite. Press Next.



- At the IQ Port screen, press the + and – keys to select the desired port option; then press Next.
- At the Radio Port screen, press the + and – keys to select the desired port option; then press Next.

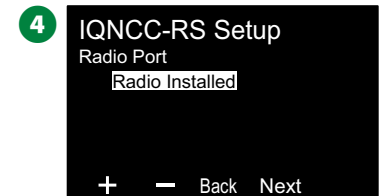
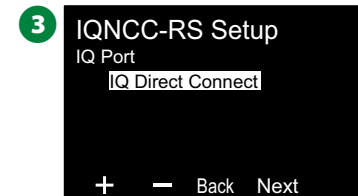

- At the CM Port screen, press the + and – keys to select the desired port option; then press Next.
- For next steps, use the NCC Configurator to configure the new satellite.

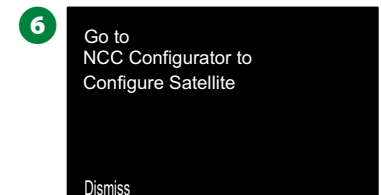
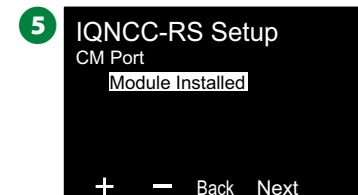

Client Satellite

- 1 At the IQNCC-RS Setup screen, press the + and – keys to select Client satellite; then press Next.
- 2 A confirmation screen shows the address of the selected IQ Satellite. Press Next.

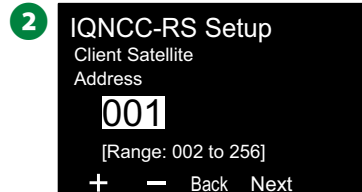

- 3 At the Radio Port screen, press the + and – keys to select the desired port option; then press Next.
- 4 At the CM Port screen, press the + and – keys to select the desired port option; then press Next.

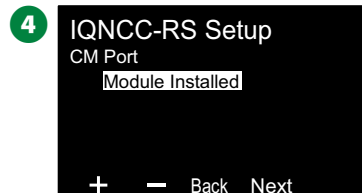
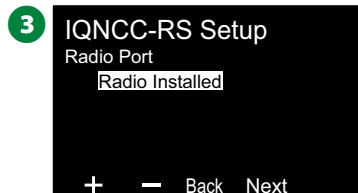

- 5 At the CM Port Termination screen, choose the ON and OFF buttons; then press Next.

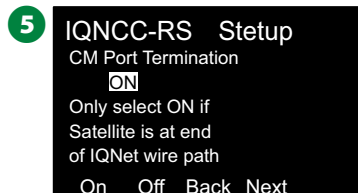

NCC Configurator



Turn the controller dial to Advanced Settings

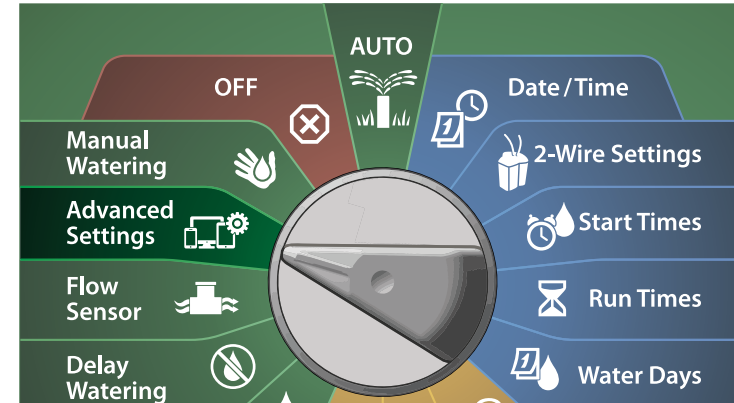

- 1 At the IQ / ADVANCED screen, press the Down Arrow key to select Configure Cartridge, then press Next.
- 2 At the IQNCC-RS Cartridge screen, press the Down Arrow key to select NCC Configurator, then press Next.

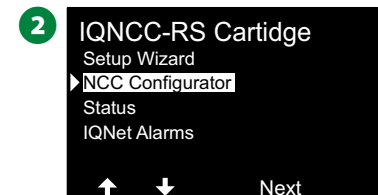
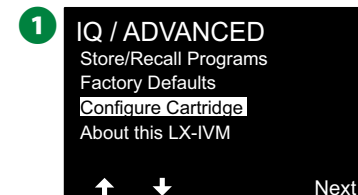

- 3 A feature description appears on the display, then press Next.
- 4 A screen shows the OFF mode selected. Press the On Button.

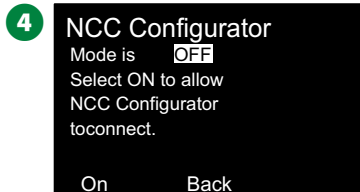
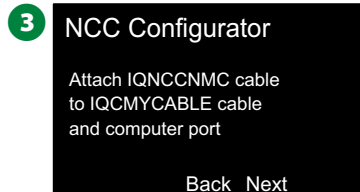

- 5 A confirmation screen shows the NCC Configurator mode is now ON.

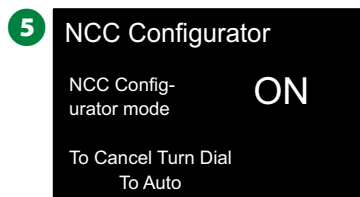

IQNCC-RS Status

 Turn the controller dial to **Advanced Settings**

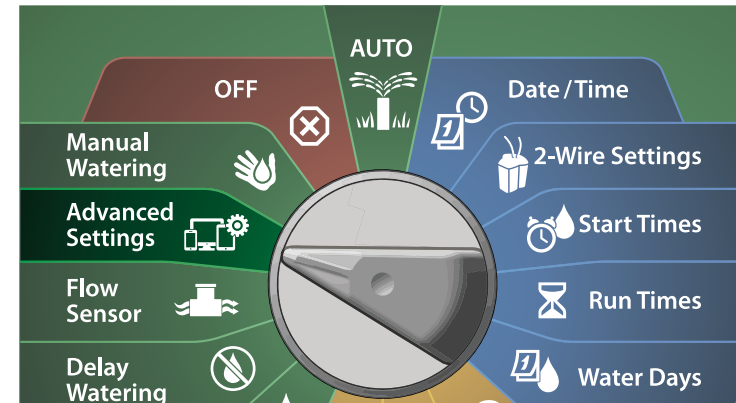

- 1 At the IQ / ADVANCED screen, press the Down Arrow key to select Configure Cartridge, then press Next.
- 2 At the IQNCC-RS Cartridge screen, press the Down Arrow key to select Status, then press Next.

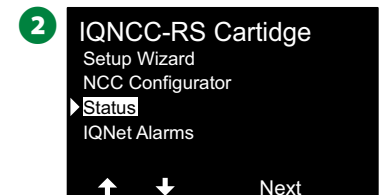
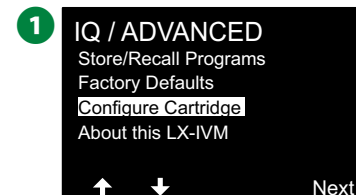

- 3 A confirmation screen shows the IQNCC-RS Status.

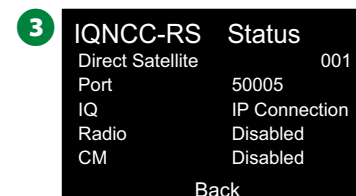

IQNet Alarms



Turn the controller dial to **Advanced Settings**

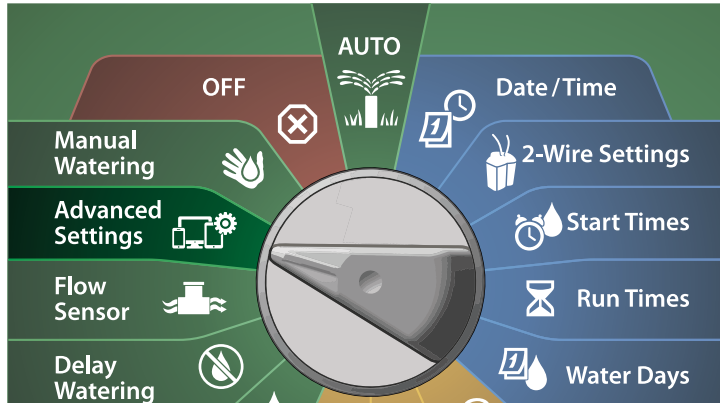

- 1 At the IQ / ADVANCED screen, press the Down Arrow key to select Configure Cartridge, then press Next.
- 2 At the IQNCC-RS Cartridge screen, press the Down Arrow key to select IQNet Alarms, then press Next.

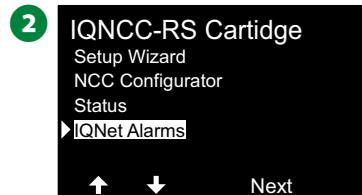
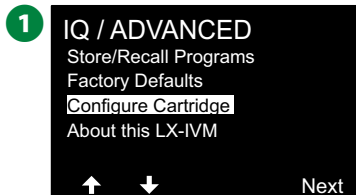

- 3 At the IQNet Alarms screen, A confirmation screen shows the process is complete.

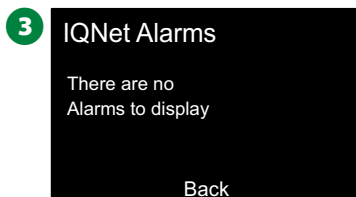



Rain Bird Corporation
6991 East Southpoint Road
Tucson, AZ 85756
USA
Tel: (520) 741-6100

Rain Bird Corporation
970 W. Sierra Madre Ave.
Azusa, CA 91702
USA
Tel: (626) 812-3400

Rain Bird International
1000 W. Sierra Madre Ave.
Azusa, CA 91702
USA
Tel: +1 (626) 963-9311

Rain Bird Turkey
Çamlık Mh. Dinç Sokak Sk. No.4 D:59-60
34760 Ümraniye, İstanbul
TÜRKIYE
Tel: (90) 216 443 75 23
rbt@rainbird.eu
www.rainbird.com.tr

Rain Bird Europe SNC
Rain Bird France SNC
240 rue René Descartes
Bâtiment A, parc Le Clamar
BP 40072
13792 AIX-EN-PROVENCE CEDEX 3
FRANCE
Tel: (33) 4 42 24 44 61
rbe@rainbird.eu · www.rainbird.eu
rbf@rainbird.eu · www.rainbird.fr

Rain Bird Deutschland GmbH
Königstraße 10c
70173 Stuttgart
DEUTSCHLAND
Tel: +49 (0) 711 222 54 158
rbd@rainbird.eu

Rain Bird Ibérica S.A.
C/ Valentín Beato, 22 2ª Izq. fdo
28037 Madrid
ESPAÑA
Tel: (34) 91 632 48 10
rbib@rainbird.eu · www.rainbird.es
portugal@rainbird.eu
www.rainbird.pt

Rain Bird Australia Pty Ltd.
Unit 13, Level1
85 Mt Derrimut Road
PO Box 183
Deer Park, VIC 3023
Tel: 1800 724 624
info@rainbird.com.au
www.rainbird.com/au

Rain Bird Brasil Ltda.
Rua Marques Póvoa, 215
Bairro Osvaldo Rezende
Uberlândia, MG, Brasil
CEP 38.400-438
Tel: 55 (34) 3221-8210
www.rainbird.com.br

Technical Support

Questions?

Call Rain Bird toll free Technical Support at
1-866-544-1406
(USA and Canada only)

Find the full ESP-LXIVM user manual and
trouble shooting information at
www.rainbird.com



"Rain Bird" and "Flo-Manager" are registered trademarks of Rain Bird Corp.

© 2020 Rain Bird Corporation D41612 Rev.07/20