

Rotary Nozzle Installation Guide

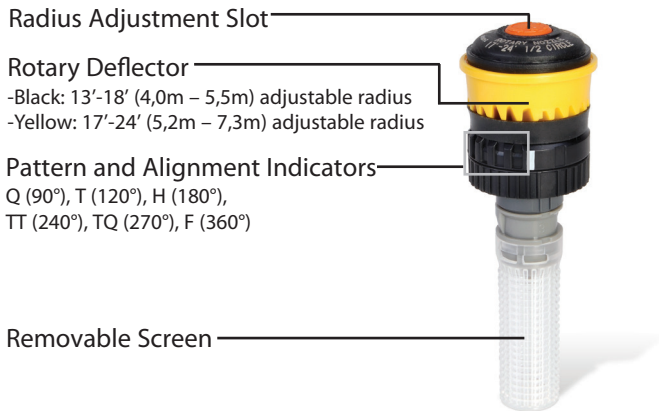

-Black: 13'-18' (4,0m – 5,5m) adjustable radius
 -Yellow: 17'-24' (5,2m – 7,3m) adjustable radius

Pattern and Alignment Indicators
 Q (90°), T (120°), H (180°),
 TT (240°), TQ (270°), F (360°)

Removable Screen

1. Important Notes Before Installation:

- Spray head must be level, at or above grade.
- Rotary Nozzles perform effectively from 20 to 55 psi (1,4 to 3,8 bar).
- Radius is determined by operating pressure at the head. See performance data.
- Install with square or triangular spacing at 50% diameter of throw (head-to-head spacing). Single row applications are not recommended.
- Application rate is much lower than standard spray nozzles. Mixing Rotary Nozzles and standard spray nozzles in the same zone is not recommended.
- Installation on Rain Bird 1800® -SAM spray heads is recommended for very sandy environments.
- Installing with Rain Bird R-VAN Adjustable Rotary Nozzles, and 5000 Series Rotor matched precipitation rate (MPR) nozzles, allows for MPR irrigation designs from 13' to 35' (4.0m 10.7m)

2. Identify Fixed Arc Pattern:

Grooved teeth patterns, located just under the deflector, correspond to individual fixed arc patterns.

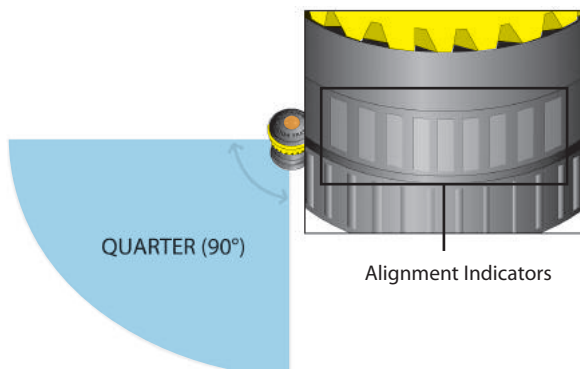

3. Initial Start-up:

Apply water to the system. Verify proper operation of the nozzles and check for leaks.

! **NOTE:** Nozzles may rotate at slightly different speeds. These nozzles maintain uniformity and apply water at the same rate, regardless of rotation speed.

4. Radius Adjustment:

If needed insert a small flat head screwdriver into the radius adjustment slot and turn the screw less than a 1/2 turn clockwise to reduce the throw distance.

It is helpful to stop the nozzle and look at the longest stream while adjusting radius.

Note: Nozzles are factory pre-set in the full open position.



Do not reduce the radius below 13'(4,0m) on the Black model (R13-18) and 17'(5,2m) on the Yellow model (R17-24).

5. Set Watering Run Time:

Reprogram the controller based on 0.6 in./hr. (14,7 mm./hr.) precipitation rate. Use a run time similar to that of rotors.



! **NOTE:** Adjust run times based on an application rate of 0.6 in./hr. (14.7 mm/hr.). Run times for R-VAN Adjustable Rotary Nozzles could be two to three times as long as standard spray nozzles.



6. Maintenance:



Clean the screen if it becomes clogged. For easier servicing, the screen may be removed by snapping it off.



! **NOTE:** The screen must be attached for best nozzle performance.



This Rotary Nozzle, as with all similar ground level installations, may be damaged by mowers or other equipment. When broken, sharp parts can be exposed. It is important that these installations be checked regularly not only to insure proper operation but also as a safety measure.



R13-18 Series (Black)					
Arc	Pressure psi	Radius* ft.	Flow gpm	■ Precip In/h	▲ Precip In/h
	20	13	1.31	0.75	0.86
	25	14	1.46	0.67	0.77
	30	16	1.60	0.61	0.70
	35	16	1.73	0.61	0.70
	40	17	1.85	0.61	0.70
	45	18	1.96	0.61	0.70
	50	18	2.07	0.61	0.70
	20	13	0.65	0.75	0.86
	25	14	0.73	0.67	0.77
	30	16	0.80	0.61	0.70
	35	16	0.86	0.61	0.70
	40	17	0.92	0.61	0.70
	45	18	0.98	0.61	0.70
	50	18	1.03	0.61	0.70
	20	13	0.33	0.75	0.86
	25	14	0.37	0.67	0.77
	30	16	0.40	0.61	0.70
	35	16	0.43	0.61	0.70
	40	17	0.46	0.61	0.70
	45	18	0.49	0.61	0.70
	55	18	0.54	0.61	0.70

R13-18 Series (Black)					METRIC
Arc	Pressure bar	Radius* m	Flow l/m	■ Precip mm/h	▲ Precip mm/h
	1.4	4.0	4.95	19	22
	1.7	4.3	5.53	18	21
	2.1	4.8	6.06	15	18
	2.4	5.0	6.54	15	18
	2.8	5.2	6.99	15	18
	3.1	5.4	7.42	15	18
	3.4	5.5	7.82	15	18
	1.4	4.0	2.47	19	22
	1.7	4.3	2.76	18	21
	2.1	4.8	3.03	15	18
	2.4	5.0	3.27	15	18
	2.8	5.2	3.50	15	18
	3.1	5.4	3.71	15	18
	3.4	5.5	3.91	15	18
	1.4	4.0	1.24	19	22
	1.7	4.3	1.38	18	21
	2.1	4.8	1.51	15	18
	2.4	5.0	1.64	15	18
	2.8	5.2	1.75	15	18
	3.1	5.4	1.85	15	18
	3.4	5.5	1.95	15	18

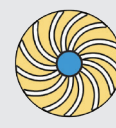
R17-24 Series (Yellow)					
Arc	Pressure psi	Radius* ft.	Flow gpm	■ Precip In/h	▲ Precip In/h
	20	17	2.45	0.79	0.92
	25	19	2.74	0.71	0.82
	30	21	3.00	0.65	0.75
	35	22	3.24	0.65	0.75
	40	23	3.46	0.65	0.75
	45	23	3.67	0.65	0.75
	50	24	3.87	0.65	0.75
	20	17	1.22	0.79	0.92
	25	19	1.37	0.71	0.82
	30	21	1.50	0.65	0.75
	35	22	1.62	0.65	0.75
	40	23	1.73	0.65	0.75
	45	23	1.84	0.65	0.75
	50	24	1.94	0.65	0.75
	20	17	0.61	0.79	0.92
	25	19	0.68	0.71	0.82
	30	21	0.75	0.65	0.75
	35	22	0.81	0.65	0.75
	40	23	0.87	0.65	0.75
	45	23	0.92	0.65	0.75
	50	24	0.97	0.65	0.75

R17-24 Series (Yellow)					METRIC
Arc	Pressure bar	Radius* m	Flow l/m	■ Precip mm/h	▲ Precip mm/h
	1.4	5.2	9.27	20	23
	1.7	5.8	10.37	18	21
	2.1	6.4	11.36	16	19
	2.4	6.7	12.26	16	19
	2.8	6.9	13.10	16	19
	3.1	7.1	13.89	16	19
	3.4	7.3	14.65	16	19
	1.4	5.2	4.62	20	23
	1.7	5.8	5.19	18	21
	2.1	6.4	5.68	16	19
	2.4	6.7	6.17	16	19
	2.8	6.9	6.55	16	19
	3.1	7.1	6.97	16	19
	3.4	7.3	7.34	16	19
	1.4	5.2	2.31	20	23
	1.7	5.8	2.57	18	21
	2.1	6.4	2.84	16	19
	2.4	6.7	3.07	16	19
	2.8	6.9	3.29	16	19
	3.1	7.1	3.48	16	19
	3.4	7.3	3.67	16	19

Note: All Rotary nozzles tested on 4" (10.2 cm) pop-ups
 ■ Square spacing based on 50% diameter of throw
 ▲ Triangular spacing based on 50% diameter of throw

Performance data taken in zero wind conditions
Note: Radius reduction over 25% of the normal throw of the nozzle is not recommended



Frequently Asked Questions:

QUESTION	ANSWER	TROUBLESHOOTING STEPS
Why do the nozzles rotate at different speeds?	This is normal. Like rotors, these nozzles maintain uniformity and put down water at the same rate, regardless of rotation speed.	N/A
Does fast rotation hurt performance or cause shorter radius?	No. Although fast rotation speed may give the appearance of shortened radius, the radius is not compromised.	Performance is not affected as long as the individual streams are visible.
Why does the pattern look short on the edges?	The pattern and edges of the Rotary Nozzle will not look the same as a standard spray head nozzle. Typical for any multi-stream rotor, the streams at the edges will be shorter than the streams at the center.	Layout with square or triangular spacing based on 50% diameter of throw (head-to-head). Single row applications are not recommended.
Why is the nozzle not rotating or starting and stopping?	<p>Radius reduction screw was used to reduce radius below 13'(4,0m) on the black model or 17'(5,2m) on the yellow model.</p> <p>Filter screen may be clogged with debris.</p> <p>Dynamic water pressure at the head may be less than the 20 psi(1,4 bar) minimum operating requirement.</p> <p>There may be a small amount of fine grit inside the nozzle.</p> <p>Water path(s) in the rotary deflector may be clogged with debris.</p> <p>Nozzle operating in a very sandy environment.</p>	<p>Turn radius reduction screw counterclockwise to increase radius.</p> <p>Remove nozzle from stem and clean the screen.</p> <p>Check water pressure and increase pressure if needed.</p> <p>Cycle the system a few times to flush.</p> <p>Visually inspect water paths in the rotary deflector and clean out debris.</p> <p>Wait 2-4 minutes to see if sand flushes out and nozzle begins to rotate. For best results in sandy conditions, use 1800° -SAM spray heads.</p>
Why is there gaps or distorted streams in the pattern?	Nozzle operating in a very sandy environment. Sand may be blocking part of the internal water path.	For best results in sandy conditions, use 1800° -SAM spray heads.

Rain Bird Corporation
Contractor, Landscape Drip,
and Accessories Divisions
970 W. Sierra Madre, Azusa, CA 91702
Phone: (626) 812-3400 Fax: (626) 812-3411

Rain Bird Corporation
Commercial Division
6991 E. Southpoint Rd., Tucson, AZ 85706
Phone: (520) 741-6100 Fax: (520) 741-6146

Rain Bird International, Inc.
145 North Grand Avenue, Glendora, CA 91741
Phone: (626) 963-9311 Fax: (626) 963-4287

Rain Bird Technical Services
(800) 247-3782 (USA & Canada only)

www.rainbird.com

© Registered Trademark of Rain Bird Corporation
© 2016 Rain Bird Corporation 5/16