



## Micro-Quick™ Sprays



Versatile, dual-deflector design gives you more options for effective irrigation

# Micro-Quick™ Sprays save water, energy and labor



A Micro-Quick™ system provides for the efficient use of water, chemicals and energy. The unique snap fit and dual deflector design greatly reduce the time and expense needed to make

system modifications for various growing conditions. Micro-Quick sprays are the only micro sprays available with reversible dual pattern deflectors featuring a selection of deflector pattern combinations available to meet your specific application requirements.

- No tools are required for assembly and disassembly.
- Nozzle/deflectors are easily removed for cleaning or to change flow rate or spray pattern.
- The taper bore nozzle design prevents debris from clogging the orifice and makes it easier to clean.
- All nozzles are color-coded by size.
- With no moving parts, Micro-Quick is virtually maintenance free.
- Can be installed in upright (upward spraying) or inverted (downward spraying) position.
- All components are protected by UV inhibitors and resist agricultural chemicals.
- Wide flow range from 3.7 GPH (13.8 l/h) to 30.6 GPH (115.7 l/h).
- 10 PSI (.69 bar) to 30 PSI (2.07 bar) pressure operation range.
- Nozzle/deflector combinations provide wetted diameter from 3 ft. (.91m) to 28 ft. (8.5m).

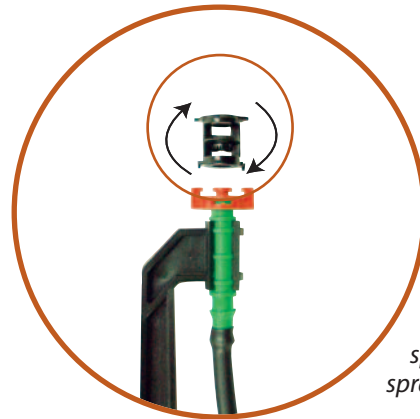

**[ E  
D ]**  
*Dual deflector design enables change from spray pattern "D" to spray pattern "E"*

## Just flip for flexibility

The unique design of the Micro-Quick deflectors allows the micro-spray system to "grow" along with the maturation of your trees. With no tools, the convenient two-sided deflector can be flipped over to quickly change the pattern.

Spray pattern configuration examples (applies to assembled Micro-Quick only):

**Spray pattern configuration DE**  
will provide spray pattern D.

**Spray pattern configuration ED**  
will provide spray pattern E.

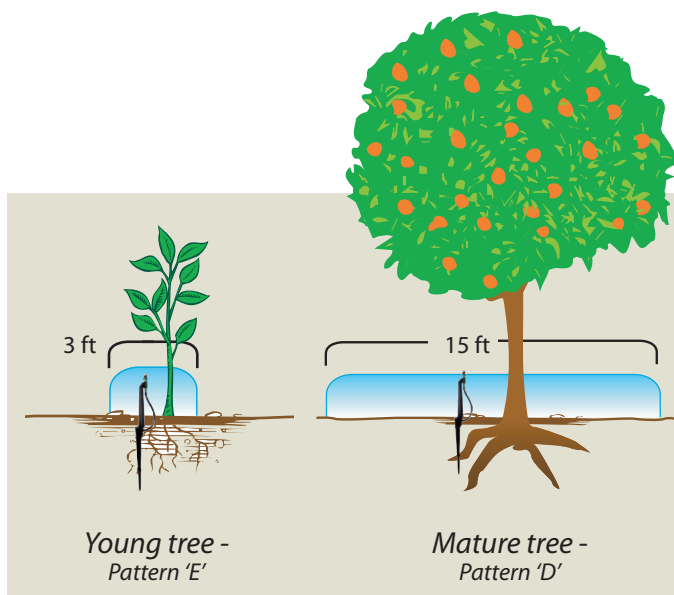

## Water application for a young tree vs. a mature tree

You can use a small diameter pattern to irrigate a young tree, then flip the deflector over to get maximum distance to irrigate the tree through maturity.

# System Components

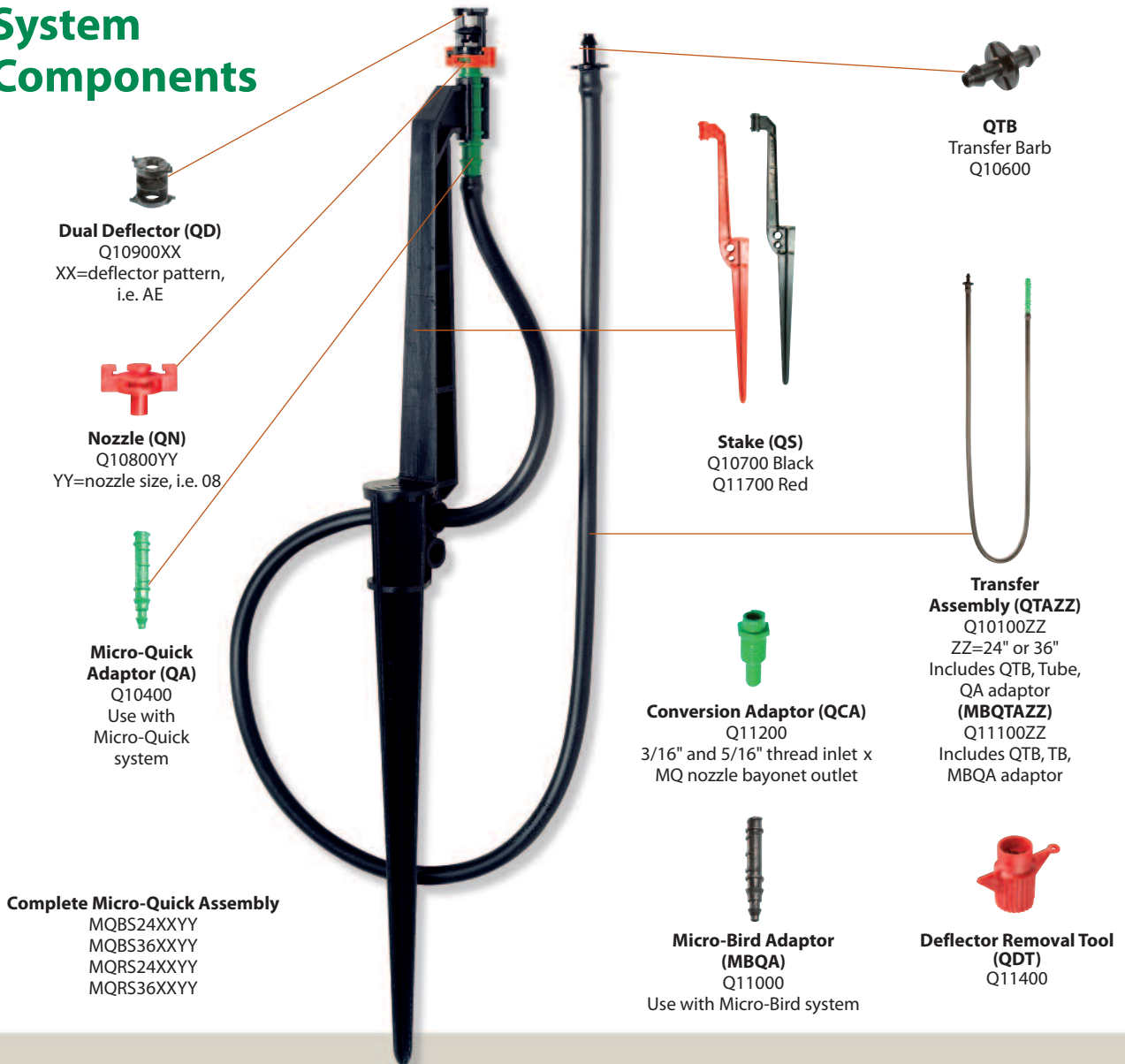

## Rain Bird® MQT™ Series 1/4" Tubing

Flexibility for ease of installation and durability for long life

The Rain Bird® MQT™ Series 1/4" distribution tubing is an ideal choice for new Micro-Quick installations or any new installation or repair where 1/4" tubing is used.

Rugged and flexible with a textured, easy-grip surface, the XQ Series can be installed above or below grade.

### Features and benefits:

- Constructed of durable, UV-resistant, polyethylene materials
- 60 psi rating

- Compatible with all 1/4" transfer fittings and all barbed outlet ports
- Unique coiling method allows the coil to remain intact as tubing is pulled out
- Available in 1000' length as a standalone coil or in a bucket

### Specifications:







- OD: 0.25" (6mm)
- ID: 0.17" (4mm)
- Wall thickness: 0.04" (1mm)

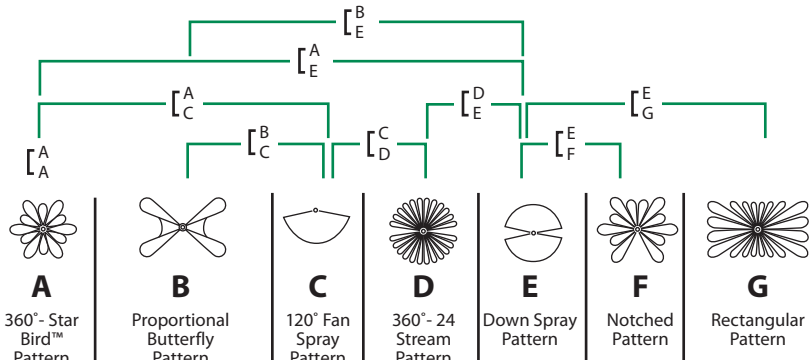

# Performance Data

US Units



MODEL (Nozzle)	Pressure (PSI)	Flow (GPH)	Diameter (ft.)	Length (ft.)	Width (ft.)	Radius (ft.)	Diameter (ft.)	Diameter (ft.)	Diameter (ft.)	Length (ft.)	Width (ft.)
 <b>QN-05</b> 0.026" Q1080005	10	3.7	8.5	8.0	7.5	4.0	8.0	3.0	10.0	9.0	6.0
	15	4.5	9.5	10.0	8.5	4.5	9.5	3.0	11.0	10.0	6.5
	20	5.2	10.5	11.0	9.0	5.0	11.0	3.0	12.0	11.0	7.0
	25	5.9	11.0	11.5	9.5	5.3	11.0	3.0	12.5	12.0	7.5
	30	6.5	11.5	12.0	10.0	5.5	11.0	3.0	13.0	13.0	8.0
 <b>QN-08</b> 0.033" Q1080008	10	5.6	13.0	10.0	7.5	4.5	9.5	3.0	12.5	12.0	7.0
	15	6.9	13.5	11.5	8.5	5.0	11.0	3.0	13.5	13.5	8.0
	20	8.0	14.0	12.5	9.5	5.5	12.5	3.0	14.0	15.0	9.0
	25	9.2	14.5	12.5	9.5	6.0	13.5	3.0	14.0	16.5	10.0
	30	10.0	15.0	13.0	10.0	6.5	14.5	3.0	14.5	18.0	10.5
 <b>QN-12</b> 0.038" Q1080018	10	7.3	17.0	11.0	9.5	4.5	11.0	3.0	14.5	15.0	8.0
	15	9.1	17.5	13.0	10.0	5.3	12.5	3.0	15.5	16.5	9.0
	20	10.6	18.0	14.5	10.5	6.0	13.5	3.0	16.0	18.0	9.5
	25	11.8	18.0	15.0	11.5	6.5	15.8	3.0	17.0	20.5	10.5
	30	13.2	18.0	15.5	12.0	7.0	18.0	3.0	17.5	23.0	11.0
 <b>QN-14</b> 0.044" Q1080014	10	9.7	19.0	13.0	10.0	5.0	12.0	3.0	16.5	15.5	8.5
	15	11.8	20.0	16.0	11.5	5.5	14.0	3.0	17.5	17.5	9.5
	20	13.7	20.5	17.0	12.0	6.0	15.5	3.0	18.5	19.5	10.0
	25	15.5	20.5	18.0	12.5	6.0	18.0	3.0	19.5	22.0	11.0
	30	17.2	21.0	19.0	13.0	7.0	20.5	3.0	20.5	24.0	11.5
 <b>QN-17</b> 0.048" Q1080017	10	10.7	21.0	15.0	10.5	6.0	13.0	3.0	17.0	16.0	9.0
	15	13.3	22.0	15.0	12.0	6.0	15.0	3.0	18.5	18.5	10.0
	20	15.5	22.5	19.0	12.5	6.0	17.0	3.0	20.0	20.5	10.5
	25	17.4	23.0	20.0	13.0	6.5	20.0	3.0	21.5	23.0	11.0
	30	19.1	23.5	21.0	13.5	7.0	23.0	3.0	23.0	25.0	12.0
 <b>QN-24</b> 0.057" Q1080024	10	14.2	23.0	16.0	11.5	6.5	15.0	3.0	18.0	18.5	11.0
	15	17.3	25.5	18.0	12.5	7.0	17.0	3.0	20.0	20.5	12.0
	20	20.1	28.0	19.5	13.0	7.5	19.0	3.0	21.5	22.0	13.0
	25	22.4	28.0	21.0	13.5	7.5	24.0	3.0	23.5	24.0	13.5
	30	26.0	28.0	22.0	14.0	7.5	25.0	3.0	25.0	25.5	14.0
 <b>QN-33</b> 0.068" Q1080033	10	17.2	25.0	18.0	11.0	7.5	17.5	3.0	19.0	21.0	13.0
	15	21.0	26.0	21.0	13.0	8.3	19.2	3.0	21.0	22.5	14.0
	20	25.2	27.0	23.0	14.5	9.0	21.0	3.0	23.0	23.5	14.5
	25	27.9	28.0	24.0	15.0	9.4	23.0	3.0	25.0	25.0	15.5
	30	30.6	28.0	25.0	15.5	9.5	25.0	3.0	27.0	26.0	16.0

Recommended Filtration (Mesh, Microns): QN-05 (200, 74), QN-08 (170, 93), QN-12 (150, 105), QN-14 (130, 118), QN-17 (120, 125), QN-24 (100, 150), QN-33 (80, 180)

## Product Specification Example

### New tree orchard with young trees





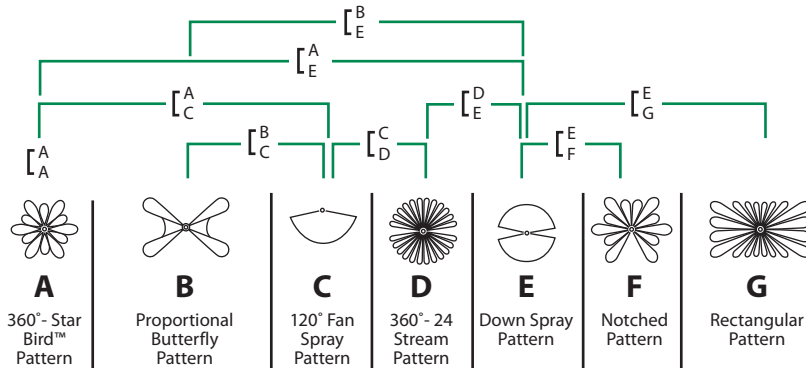

A grower has selected deflector ED. The E pattern will provide the tight, full coverage required by the newly planted trees, and the wider radius D pattern will be well suited in the future as trees mature. The grower selects the QN-08 orange nozzle that provides 8 gph at 20 psi. He then chooses the 36" transfer tubing

as it will allow placement flexibility when the deflector is flipped and then mounts the nozzles with the black stake.

This model number designation is **MQBS36ED08**.

## Metric Units



MODEL (Nozzle)	Pressure (bar)	Flow (l/h)	Diameter (m)	Length (m)	Width (m)	Radius (m)	Diameter (m)	Diameter (m)	Diameter (m)	Diameter (m)	Length (m)	Width (m)
 <b>QN-05</b> 0.026" Q1080005	0.75	13.8	2.6	2.4	2.3	1.2	2.4	0.9	3.0	2.7	1.80	
	1.00	17.2	2.9	3.0	2.6	1.4	2.9	0.9	3.3	3.0	2.00	
	1.50	19.8	3.3	3.3	2.7	1.6	3.2	0.9	3.6	3.3	2.10	
	1.75	22.3	3.4	3.5	2.9	1.6	3.4	0.9	3.8	3.6	2.25	
	2.00	24.5	3.5	3.7	3.0	1.7	3.4	0.9	4.0	4.0	2.40	
 <b>QN-08</b> 0.033" Q1080008	0.75	21.0	3.7	3.0	2.3	1.4	2.9	0.9	3.8	3.6	2.1	
	1.00	26.3	3.8	3.5	2.6	1.5	3.3	0.9	4.1	4.1	2.4	
	1.50	30.1	4.3	3.8	2.9	1.7	3.8	0.9	4.2	4.6	2.7	
	1.75	34.6	4.4	3.8	2.9	1.8	4.0	0.9	4.2	5.0	3.01	
	2.00	37.8	4.5	4.0	3.0	2.0	4.2	0.9	4.4	5.4	3.2	
 <b>QN-12</b> 0.038" Q1080018	0.75	27.6	5.1	3.4	2.9	1.4	3.3	0.9	4.4	4.6	2.4	
	1.00	34.5	5.3	4.0	3.0	1.6	3.7	0.9	4.7	5.0	2.7	
	1.50	40.0	5.4	4.4	3.2	1.9	4.0	0.9	4.9	5.4	2.9	
	1.75	44.7	5.5	4.6	3.5	2.0	4.8	0.9	5.1	6.2	3.2	
	2.00	49.9	5.5	4.7	3.7	2.1	5.3	0.9	5.3	7.0	3.3	
 <b>QN-14</b> 0.044" Q1080014	0.75	36.5	5.8	4.0	3.0	1.5	3.6	0.9	5.0	4.7	2.6	
	1.00	44.6	6.1	4.9	3.5	1.7	4.2	0.9	5.3	5.3	2.9	
	1.50	52.0	6.3	5.2	3.7	1.8	5.0	0.9	5.6	5.9	3.0	
	1.75	58.7	6.3	5.5	3.8	1.9	5.5	0.9	5.9	6.7	3.3	
	2.00	65.0	6.4	5.8	4.0	2.1	6.1	0.9	6.2	7.3	3.5	
 <b>QN-17</b> 0.048" Q1080017	0.75	40.5	6.4	4.6	3.2	1.8	4.0	0.9	5.1	4.9	2.7	
	1.00	50.5	6.7	5.2	3.7	1.8	4.5	0.9	5.6	5.6	3.0	
	1.50	58.5	6.9	5.8	3.8	1.9	5.5	0.9	6.1	6.2	3.2	
	1.75	65.9	7.0	6.1	4.0	2.0	6.0	0.9	6.5	7.0	3.3	
	2.00	72.3	7.1	6.4	4.1	2.1	6.8	0.9	7.0	7.6	3.7	
 <b>QN-24</b> 0.057" Q1080024	0.75	53.9	7.1	4.9	3.5	2.0	4.6	0.9	5.4	5.6	3.3	
	1.00	65.6	7.8	5.5	3.8	2.2	5.1	0.9	6.1	6.2	3.7	
	1.50	76.0	8.2	5.9	4.0	2.2	6.3	0.9	6.5	6.7	3.9	
	1.75	84.9	8.5	6.4	4.1	2.3	7.0	0.9	7.1	7.3	4.1	
	2.00	98.4	8.5	6.7	4.3	2.3	7.3	0.9	7.6	7.7	4.2	
 <b>QN-33</b> 0.068" Q1080033	0.75	65.1	7.6	5.5	3.4	2.3	5.4	0.9	5.8	6.4	3.9	
	1.00	79.5	7.9	6.4	4.0	2.5	5.8	0.9	6.4	6.9	4.2	
	1.50	95.3	8.3	7.0	4.4	2.8	6.6	0.9	7.0	7.1	4.4	
	1.75	105.7	8.4	7.3	4.6	2.9	7.1	0.9	7.6	7.6	4.7	
	2.00	115.7	8.5	7.6	4.7	2.9	7.5	0.9	8.2	7.9	4.9	

Recommended Filtration (Mesh, Microns): QN-05 (200, 74), QN-08 (170, 93), QN-12 (150, 105), QN-14 (130, 118), QN-17 (120, 125), QN-24 (100, 150), QN-33 (80, 180)

## Specify fully assembled unit by model number

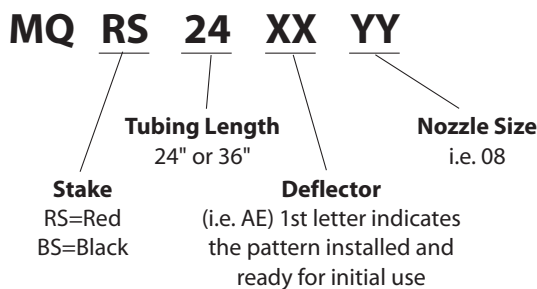

## A legacy of agricultural innovation

---

Rain Bird has a rich history serving the agricultural community. Beginning in 1933 with the invention of the original horizontal action impact drive sprinkler by a Glendora, California citrus farmer (U.S. Patent #1,997,901), Rain Bird revolutionized the food production industry and ushered in a new era in irrigation, worldwide. The original impact sprinkler was designated a historic landmark in 1990 by the American Society of Agricultural Engineers.



Rain Bird has been awarded more than 130 patents for innovative irrigation products and technologies. Today, Rain Bird products are used in over 130 countries around the world to irrigate nearly every imaginable crop. Rain Bird is committed to The Intelligent Use of Water™, bringing its expertise and knowledge to further increase irrigation efficiency, minimize maintenance costs and enhance the health of crops.

**Visit [www.rainbird.com/ag/products/microsprays](http://www.rainbird.com/ag/products/microsprays) for more information.**

---



### **Rain Bird Corporation**

970 W. Sierra Madre Ave.  
Azusa, CA 91702  
Phone: (626) 812-3400  
Fax: (626) 812-3608

### **Rain Bird Technical Services**

(800) RAINBIRD (800-624-6247)  
(U.S. and Canada only)

### **Rain Bird Corporation**

6991 East Southpoint Road  
Tucson, AZ 85756  
Phone: (520) 741-6100  
Fax: (520) 741-6522

### **Specification Hotline**

(800) 458-3005 ( U.S. and Canada)

### **Rain Bird International, Inc.**

1000 W. Sierra Madre Ave.  
Azusa, CA 91702  
Phone: (626) 963-9311  
Fax: (626) 852-7343

[www.rainbird.com](http://www.rainbird.com)